

Specification

PATENT PENDING

Part No.	:	MA961.W.A.BICG.002.wm
Product Name	:	Guardian 4in1 Wall Mount Antenna 2*LTE MIMO and 2*Wi-Fi MIMO
Features	:	Low-Profile Housing Mount on Wall or Glass 2*LTE MIMO 698-960MHz / 1710-2170MHz /2490-2690MHz / 3300-3600MHz 2*Dual Band Wi-Fi MIMO 2400MHz to 2500MHz / 4900MHz to 5850MHz Worldwide 4G Bands including fallback to 3G and 2G IP67 Waterproof Enclosure Dims: 146*134*20mm Cables: 3M Low Loss KSR200-P and RG174 Connectors: SMA(M)/RP-SMA(M) Cables and Connectors Customizable RoHS Compliant

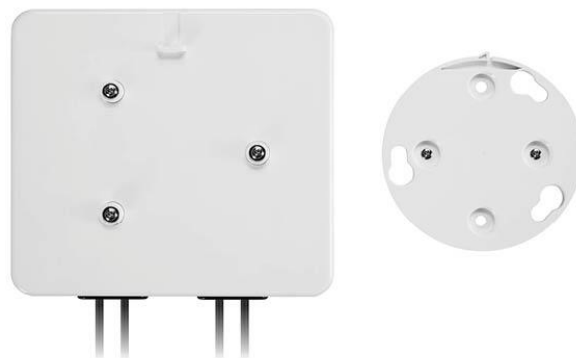

1. Introduction

The MA961 Guardian is a next generation combination antenna. The first panel antenna worldwide designed for IoT Gateway and Router devices. It is a low profile 4in1 wall mount antenna. This unique product delivers powerful worldwide 4G LTE MIMO antenna technology at 700MHz/800MHz/1700MHz/1800MHz/2600MHz/3500MHz and dual band Wi-Fi. It is a heavy-duty, fully IP67 waterproof external M2M antenna for use by RF professionals in IoT Gateway and Routers, HD Video Streaming, Transportation and Remote Monitoring Applications.

This antenna delivers powerful MIMO antenna technology for worldwide 4G LTE bands at 698-960MHz / 1710-2170MHz / 2490-2690MHz / 3300-3600MHz bands and dual 2.4/5.8GHz Wi-Fi. It enables designers to cover a wide range of technologies by installing a single antenna.

4G wireless applications demand high speed data uplink and downlink. High efficiency and high gain MIMO antennas are necessary to achieve the required signal to noise ratio and throughput required to solve these challenges. Taoglas also takes care to have high isolation among these antennas to prevent self-interference. Low loss cables used to keep efficiency high over long cable lengths.

The housing is made of durable ASA, is IP67 waterproof and comes with a wall mount. The antenna can be mounted internally or externally on a vehicle or building. The MA961 comes with 3 meters CFD-200 cable as standard. Customized cables and connector versions are also available.

2. Specification

4G/3G/2G MIMO1 Antenna									
Frequency (MHz)	LTE700	GSM850	GSM900	DCS	PCS	UMTS1	LTE2600	LTE3500	
	698~803	824~894	880~960	1710~1880	1850~1990	1920~2170	2490~2690	3300~3600	
Efficiency (%)									
In free space	30cm	80.59	64.37	61.48	67.87	72.91	76.16	47.65	55.23
	1M	76.15	61.48	58.71	61.90	66.50	70.02	43.45	49.00
	2M	71.06	56.46	53.55	55.17	58.52	61.35	37.52	41.47
	3M	65.87	52.33	49.65	49.03	51.74	54.25	32.54	35.03
	5M	56.97	44.54	41.98	38.65	40.59	42.27	24.39	25.12
Average Gain (dBi)									
In free space	30cm	-0.95	-1.92	-2.11	-1.69	-1.37	-1.19	-3.42	-2.64
	1M	-1.19	-2.12	-2.31	-2.09	-1.77	-1.55	-3.82	-3.17
	2M	-1.49	-2.49	-2.71	-2.59	-2.33	-2.13	-4.45	-3.89
	3M	-1.82	-2.82	-3.04	-3.10	-2.86	-2.66	-5.08	-4.62
	5M	-2.45	-3.52	-3.77	-4.13	-3.92	-3.75	-6.33	-6.07
Peak Gain (dBi)									
In free space	30cm	3.83	3.32	1.83	4.23	4.23	4.70	4.11	3.36
	1M	3.63	3.12	1.63	3.83	3.83	4.30	3.71	3.36
	2M	3.33	2.82	1.23	3.33	3.33	3.80	3.11	2.66
	3M	3.03	2.42	0.85	2.73	2.73	3.20	2.51	1.86
	5M	2.33	1.72	0.15	1.73	1.73	2.10	1.31	0.46
4G/3G/2G MIMO2 Antenna									
Efficiency (%)									
In free space	30cm	80.00	63.77	59.51	67.36	72.20	76.03	57.82	64.24
	1M	75.66	60.90	56.84	61.43	65.84	69.92	52.74	56.94
	2M	70.61	55.93	51.83	54.75	57.94	61.24	45.51	48.21
	3M	65.44	51.84	48.09	48.66	51.23	54.16	39.45	40.77
	5M	56.55	44.12	40.66	38.36	40.18	42.20	29.58	29.22
Average Gain (dBi)									
In free space	30cm	-0.99	-1.96	-2.26	-1.72	-1.42	-1.20	-2.47	-1.93
	1M	-1.23	-2.16	-2.46	-2.12	-1.82	-1.56	-2.87	-2.46
	2M	-1.53	-2.53	-2.86	-2.62	-2.37	-2.14	-3.50	-3.18
	3M	-1.86	-2.86	-3.19	-3.13	-2.91	-2.67	-4.13	-3.91
	5M	-2.49	-3.56	-3.92	-4.16	-3.96	-3.76	-5.38	-5.36
Peak Gain (dBi)									
In free space	30cm	4.86	3.06	2.81	4.41	4.67	4.56	3.95	4.15
	1M	4.66	2.86	2.61	4.01	4.27	4.19	3.55	3.55
	2M	4.36	2.56	2.21	3.51	3.77	3.66	2.95	2.85
	3M	4.06	2.16	1.91	2.99	3.17	3.06	2.35	2.15
	5M	3.36	1.46	1.21	1.99	2.17	2.06	1.15	0.65
Impedance		50Ω							
Polarization		Linear							
VSWR		< 3							
Cable		3 meters CFD-200 standard, fully customizable							
Connector		SMA(M) standard, fully customizable							

ELECTRICAL			
Frequency (MHz)		2400~2500	4900~5850
Efficiency (%)			
MIMO_1	30cm	69.77	59.81
	1M	63.63	51.43
	2M	55.42	41.67
	3M	48.27	33.81
	5M	36.62	22.18
MIMO_2	30cm	70.19	59.69
	1M	64.01	51.32
	2M	55.75	41.57
	3M	48.56	33.71
	5M	36.84	22.12
Average Gain (dBi)			
MIMO_1	30cm	-1.57	-2.27
	1M	-1.97	-2.92
	2M	-2.57	-3.84
	3M	-3.17	-4.75
	5M	-4.37	-6.58
MIMO_2	30cm	-1.54	-2.25
	1M	-1.94	-2.91
	2M	-2.54	-3.82
	3M	-3.14	-4.73
	5M	-4.34	-6.56
Peak Gain (dBi)			
MIMO_1	30cm	4.87	4.95
	1M	4.37	4.26
	2M	3.77	3.36
	3M	3.17	2.46
	5M	1.97	0.66
MIMO_2	30cm	4.93	5.09
	1M	4.43	4.39
	2M	3.83	3.49
	3M	3.23	2.59
	5M	2.03	0.79
MECHANICAL			
Antenna Dimensions	146*134*20mm		
Casing	ABS+PC		
Base and thread	Nickel Plated Aluminum		
Weight	586g		
Ingress Protection Rating	IP67		
ENVIRONMENTAL			
Operation Temperature	-40°C to 85°C		
Storage Temperature	-40°C to 90°C		
Humidity	Non-condensing 65°C 95% RH		

LTE BANDS				
Band Number	LTE / LTE-Advanced / WCDMA / HSPA / HSPA+ / TD-SCDMA			
	Uplink	Downlink	MIMO 1	MIMO 2
1	UL: 1920 to 1980	DL: 2110 to 2170	✓	✓
2	UL: 1850 to 1910	DL: 1930 to 1990	✓	✓
3	UL: 1710 to 1785	DL: 1805 to 1880	✓	✓
4	UL: 1710 to 1755	DL: 2110 to 2155	✓	✓
5	UL: 824 to 849	DL: 869 to 894	✓	✓
7	UL: 2500 to 2570	DL: 2620 to 2690	✓	✓
8	UL: 880 to 915	DL: 925 to 960	✓	✓
9	UL: 1749.9 to 1784.9	DL: 1844.9 to 1879.9	✓	✓
11	UL: 1427.9 to 1447.9	DL: 1475.9 to 1495.9	✗	✗
12	UL: 699 to 716	DL: 729 to 746	✓	✓
13	UL: 777 to 787	DL: 746 to 756	✓	✓
14	UL: 788 to 798	DL: 758 to 768	✓	✓
17	UL: 704 to 716	DL: 734 to 746 (LTE only)	✓	✓
18	UL: 815 to 830	DL: 860 to 875 (LTE only)	✓	✓
19	UL: 830 to 845	DL: 875 to 890	✓	✓
20	UL: 832 to 862	DL: 791 to 821	✓	✓
21	UL: 1447.9 to 1462.9	DL: 1495.9 to 1510.9	✗	✗
22	UL: 3410 to 3490	DL: 3510 to 3590	✓	✓
23	UL: 2000 to 2020	DL: 2180 to 2200 (LTE)	✓	✓
24	UL: 1625.5 to 1660.5	DL: 1525 to 1559 (LTE)	✓	✓
25	UL: 1850 to 1915	DL: 1930 to 1995	✓	✓
26	UL: 814 to 849	DL: 859 to 894	✓	✓
27	UL: 807 to 824	DL: 852 to 869 (LTE only)	✓	✓
28	UL: 703 to 748	DL: 758 to 803 (LTE only)	✓	✓
29	UL: -	DL: 717 to 728 (LTE only)	✓	✓
30	UL: 2305 to 2315	DL: 2350 to 2360 (LTE)	✓	✓
31	UL: 452.5 to 457.5	DL: 462.5 to 467.5 (LTE)	✗	✗
32	UL: -	DL: 1452 - 1496	✓	✓
35		1850 to 1910	✓	✓
38		2570 to 2620	✗	✓
39		1880 to 1920	✓	✓
40		2300 to 2400	✓	✓
41		2496 to 2690	✗	✓
42		3400 to 3600	✓	✓
43		3600 to 3800	✓	✓

*Covered bands represent an efficiency greater than 20%

3 Antenna Characteristics

3.1 LTE MIMO/Wi-Fi MIMO Antenna

3.1.1 Test Setup



Free space

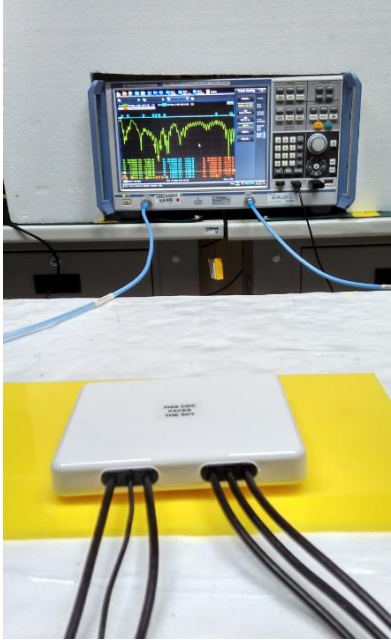

ABS

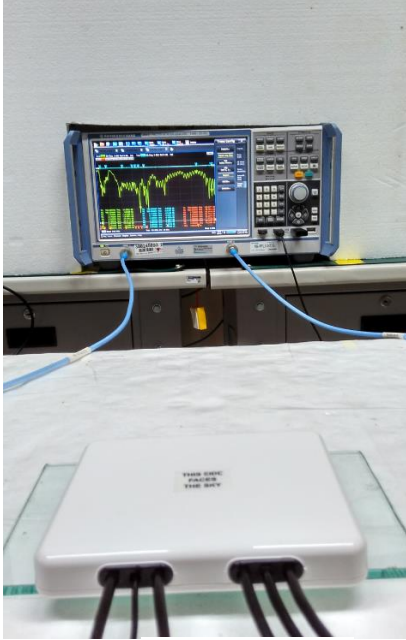

Glass

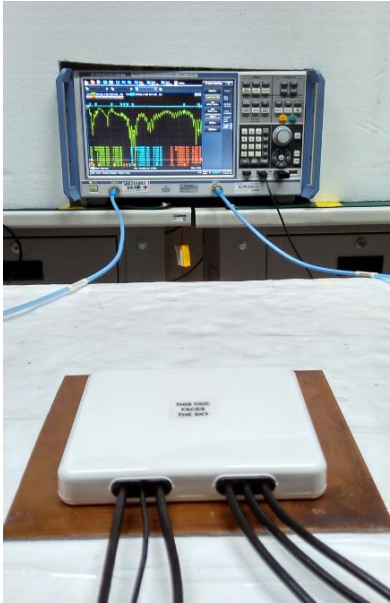

Metal

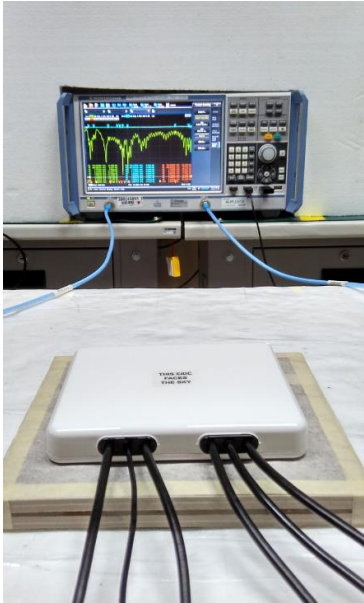

Wall

3.1.2 LTE 1 Antenna Return Loss

Performance in different environments with 1 meter cable length

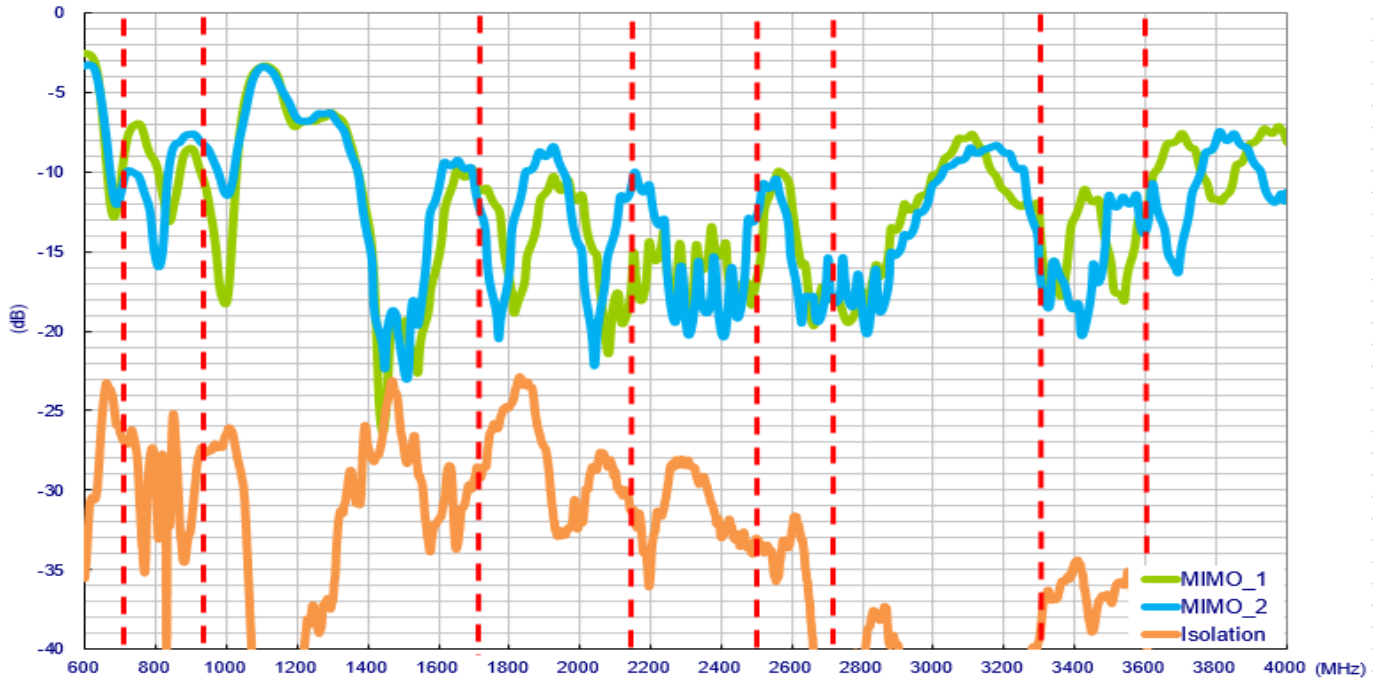

Figure 1. Return loss of MA961 LTE MIMO antenna in free space

3.1.3 LTE Antenna Efficiency

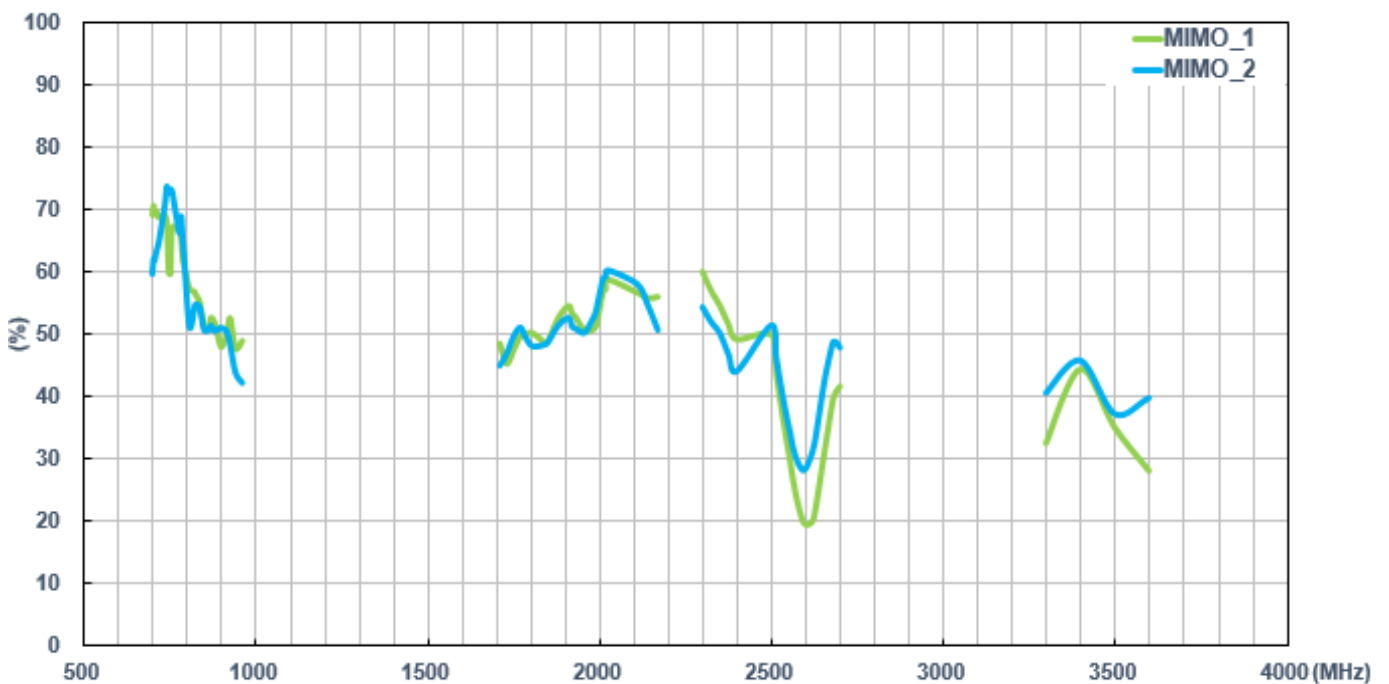

Figure 2. Efficiency of MA961 LTE MIMO antenna in free space

3.1.4 LTE Antenna Average Gain

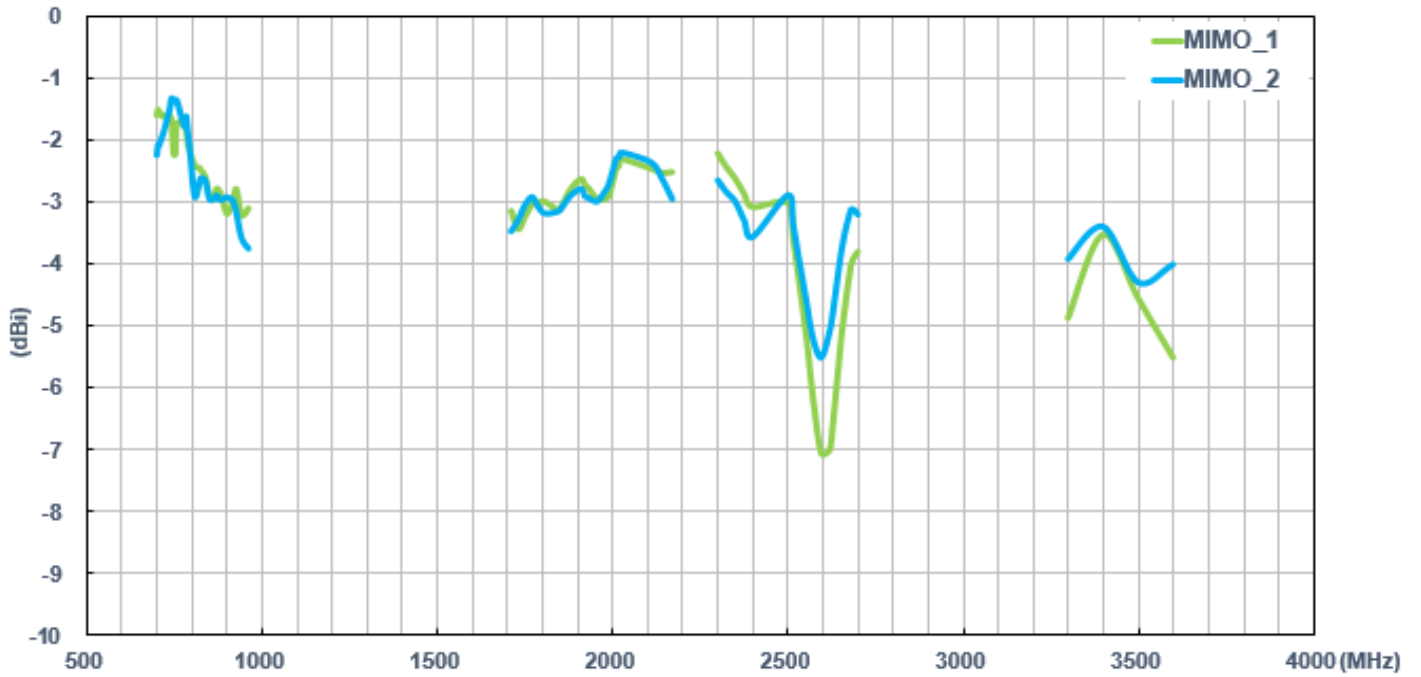

Figure 3. Average gain of MA961 LTE MIMO antenna in free space

3.1.5 LTE Antenna Peak Gain

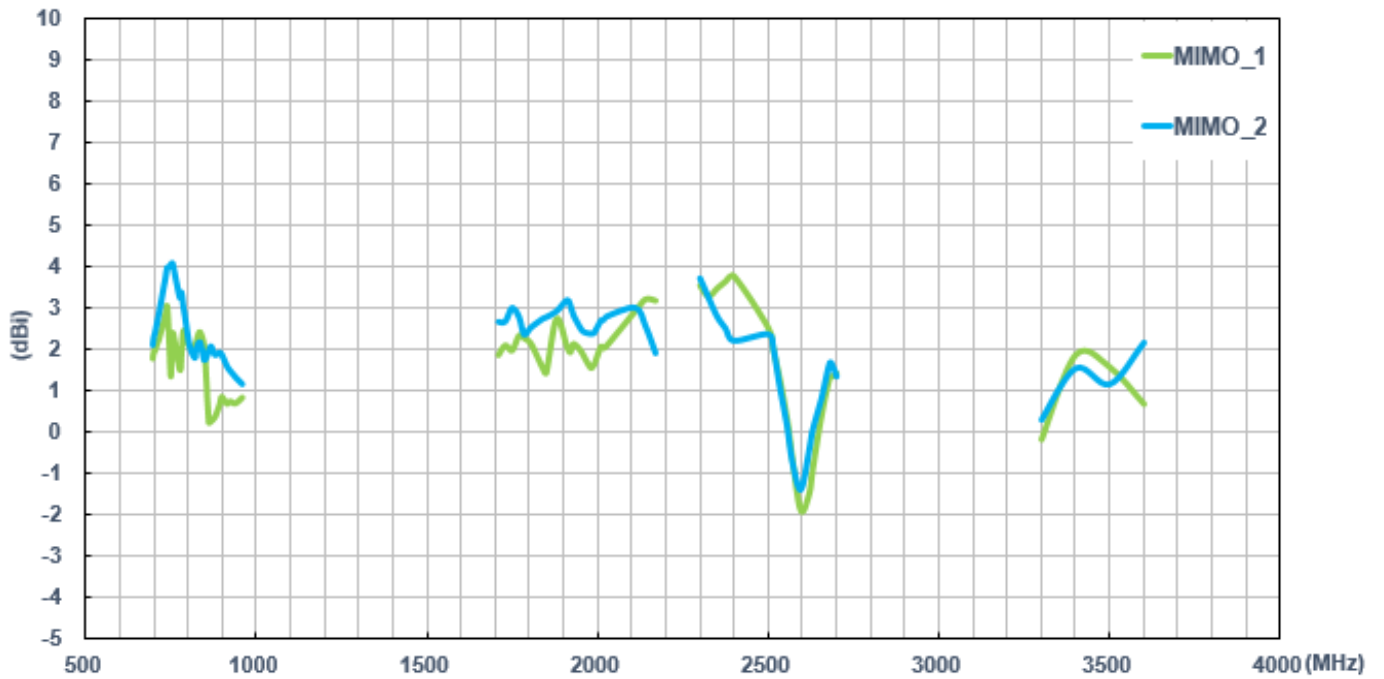

Figure 4. Peak gain of MA961 LTE MIMO antenna in the free space

3.2 Wi-Fi MIMO Antenna

3.2.1 Wi-Fi Antenna Return Loss and Isolation with 3-meter cable length

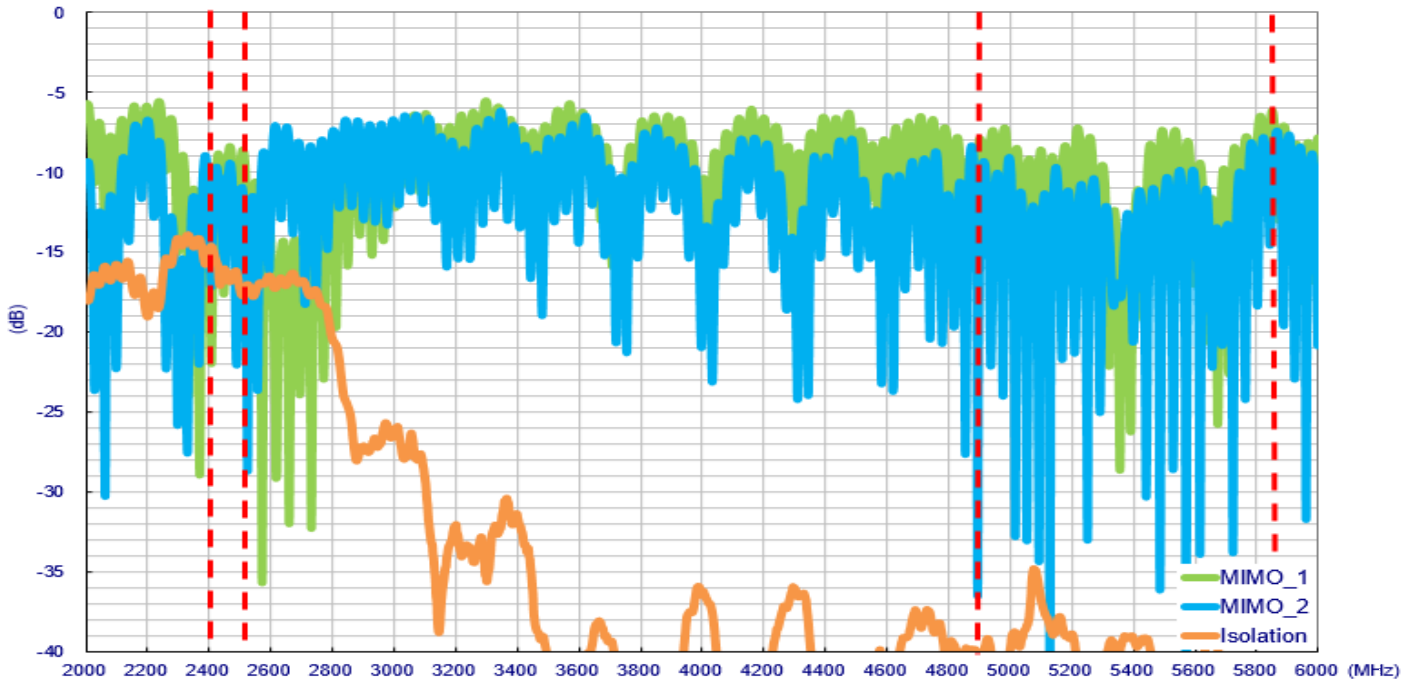

Figure 5. Return loss of MA961 Wi-Fi MIMO antenna in free space

3.2.2 Wi-Fi Antenna Efficiency

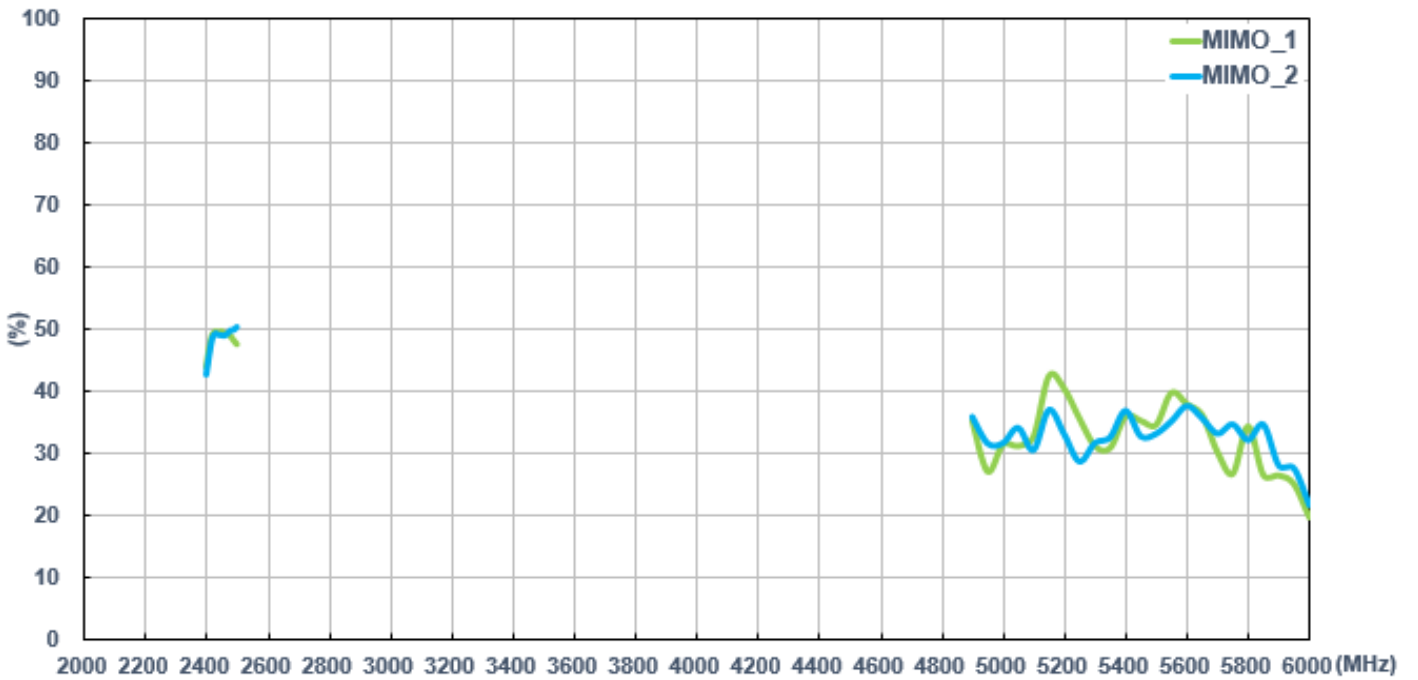

Figure 6. Efficiency of MA961 Wi-Fi MIMO antenna in free space

3.2.3 Wi-Fi Antenna Average Gain

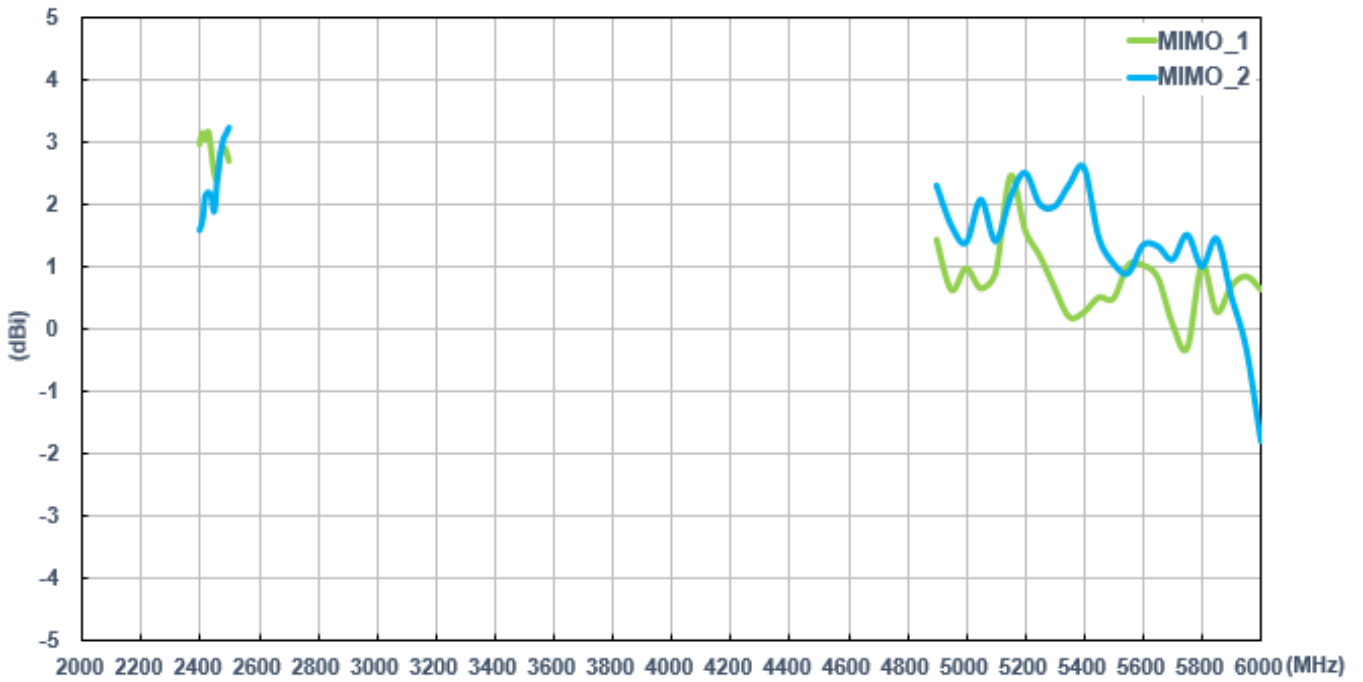

Figure 7. Average gain of MA961 Wi-Fi MIMO antenna in free space

3.2.4 Wi-Fi Antenna Peak Gain

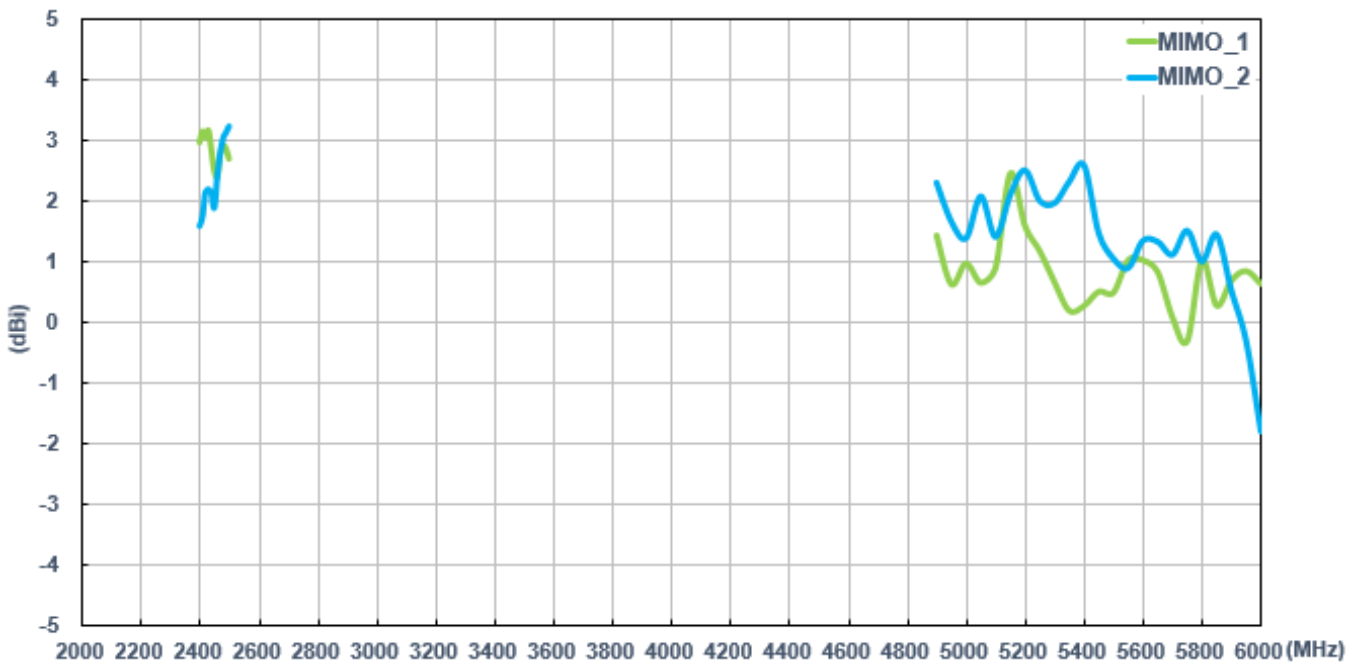
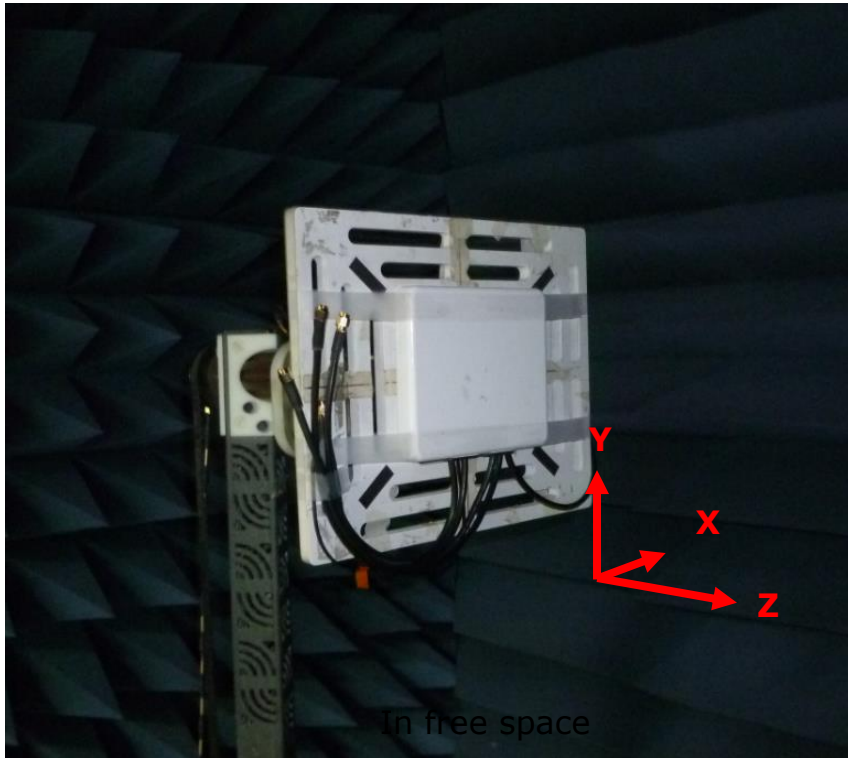

Figure 8. Peak gain of MA961 Wi-Fi MIMO antenna in the free space

3.3 Test Setup for Antenna Radiation Pattern (ETS Anechoic chamber)



3.1.21 2D Radiation Pattern (LTE MIMO1 with 3M cable length in free space)

XY Plane

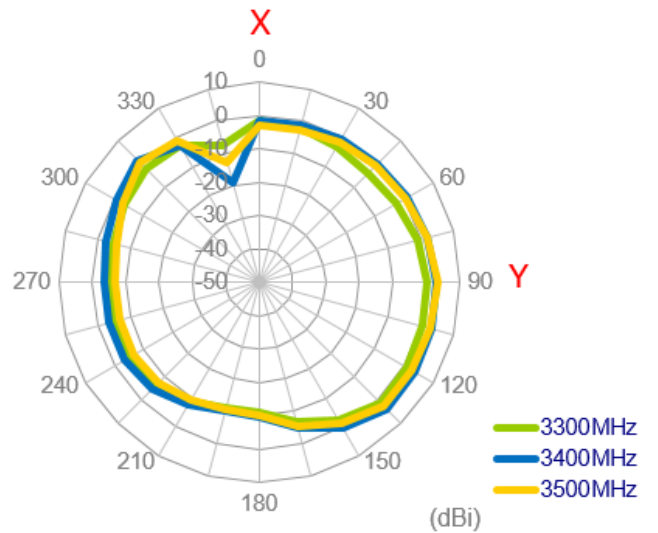
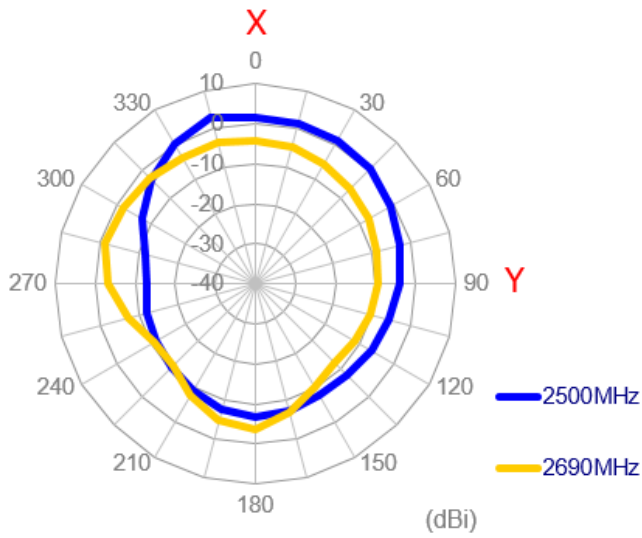
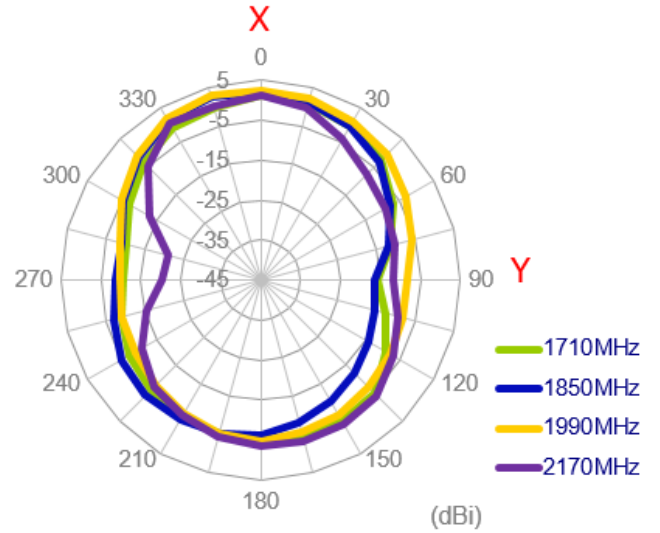
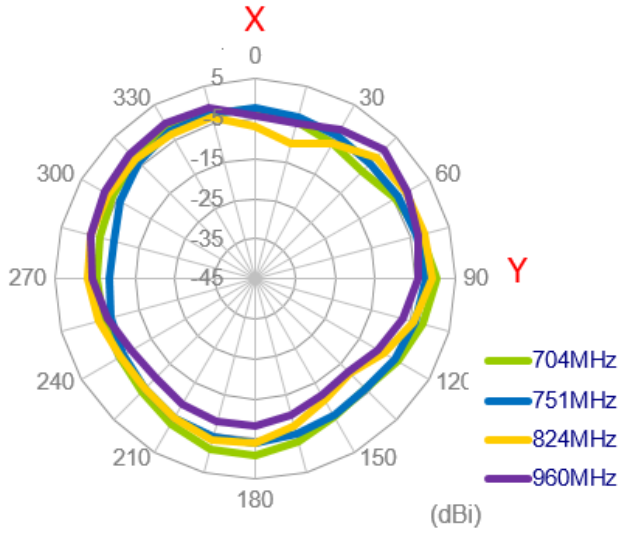

XZ Plane

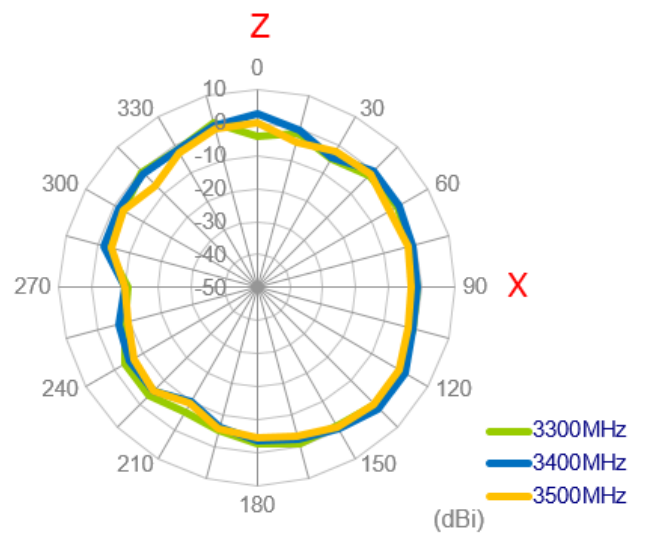
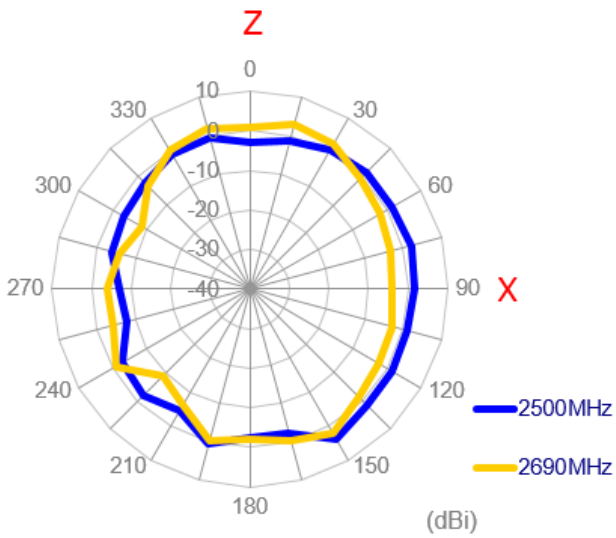
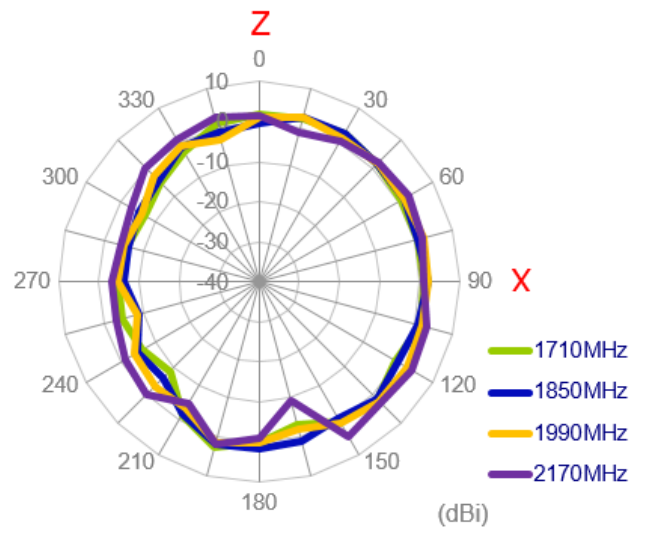
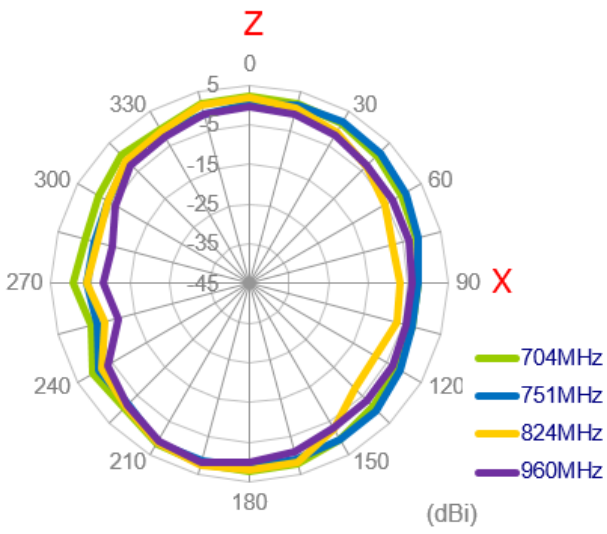

YZ Plane

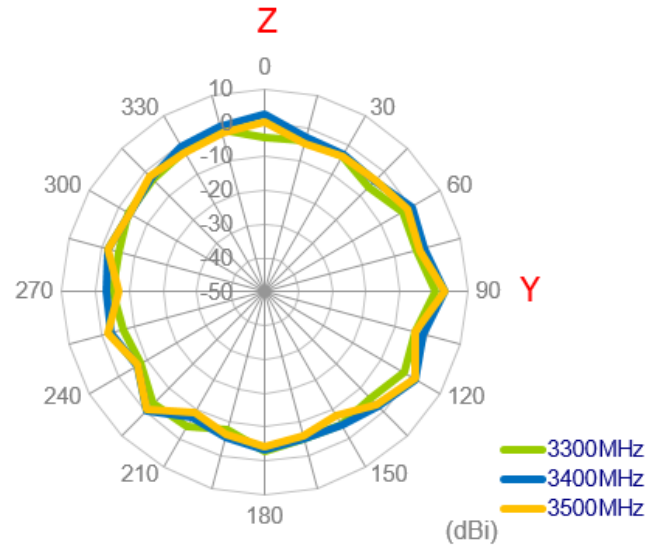
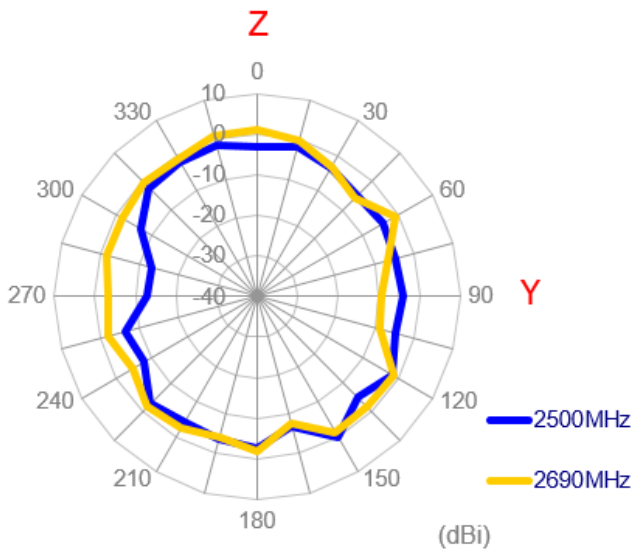
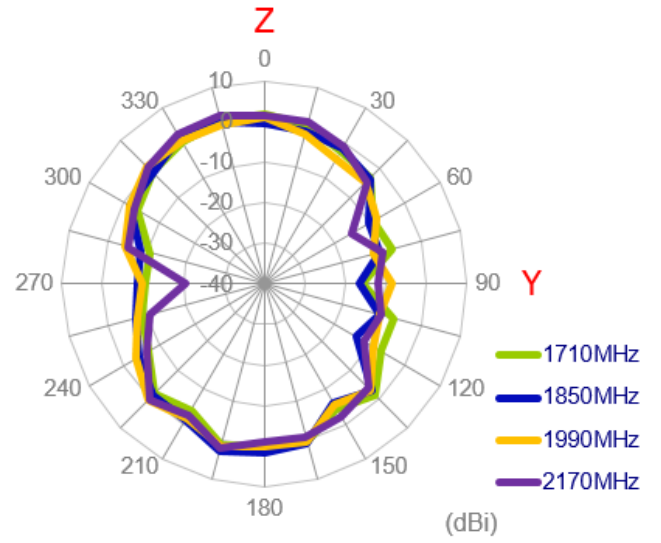
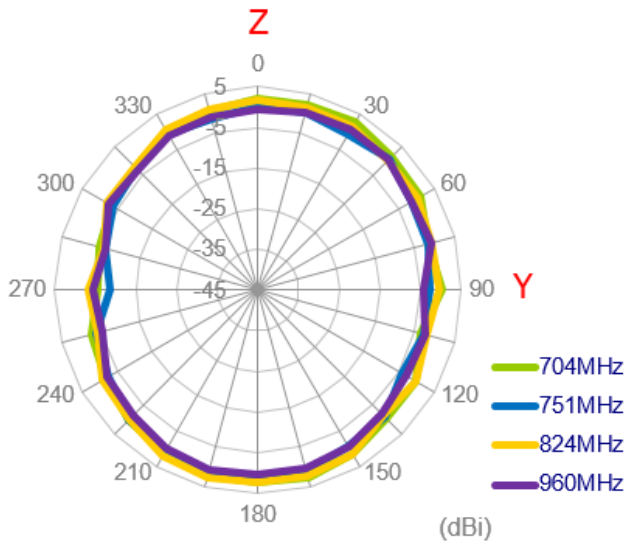

3.3.2 3D Radiation Pattern (LTE MIMO1 with 3M cable length in free space)

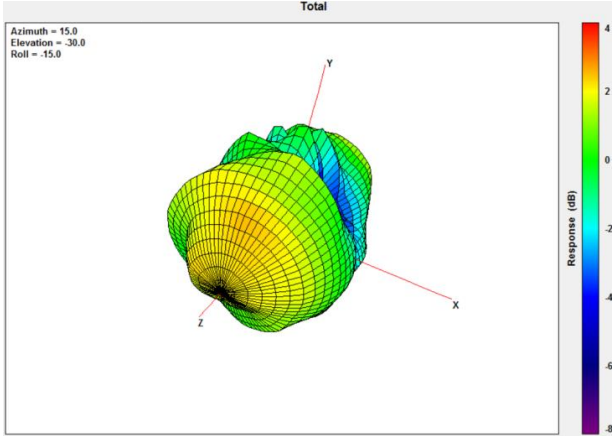

704MHz

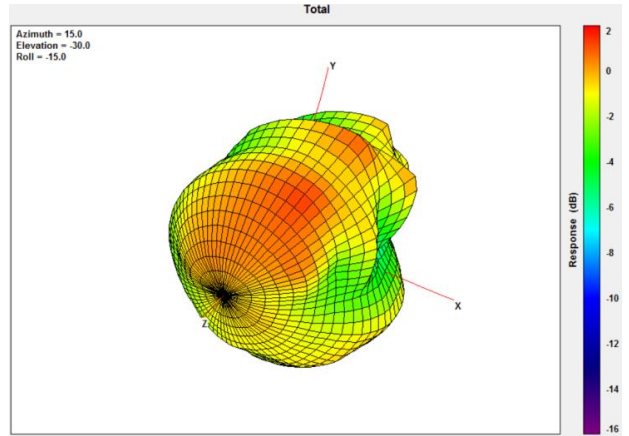

960MHz

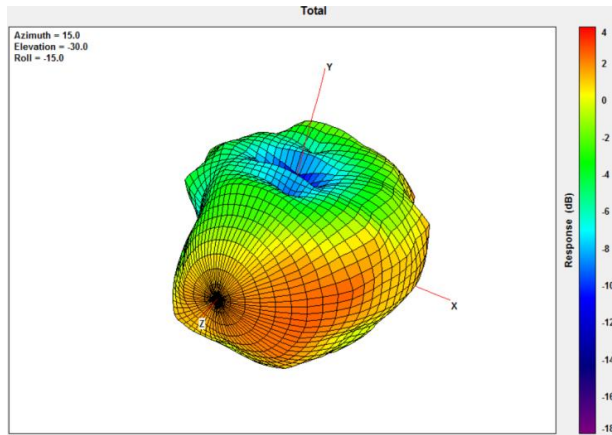

1710MHz

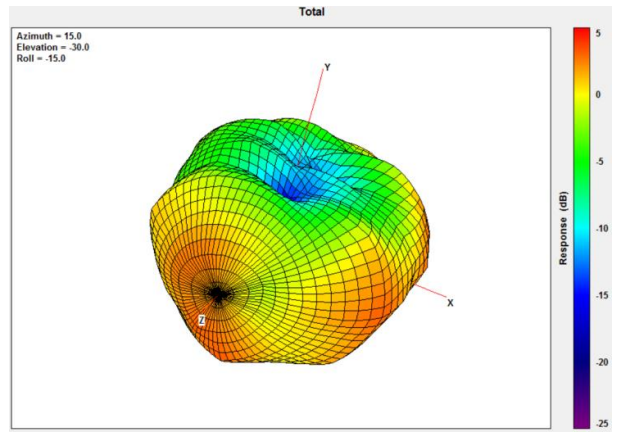

2170MHz

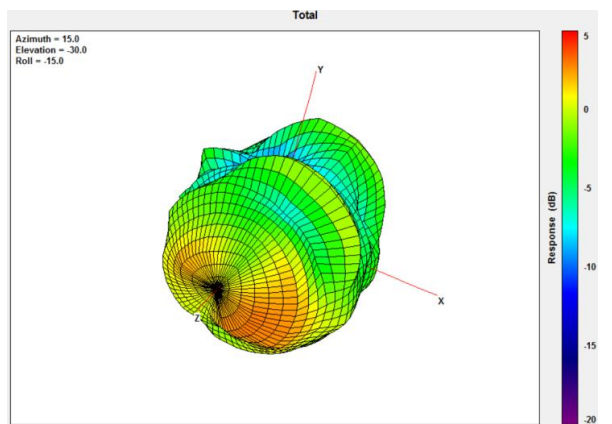

2690MHz

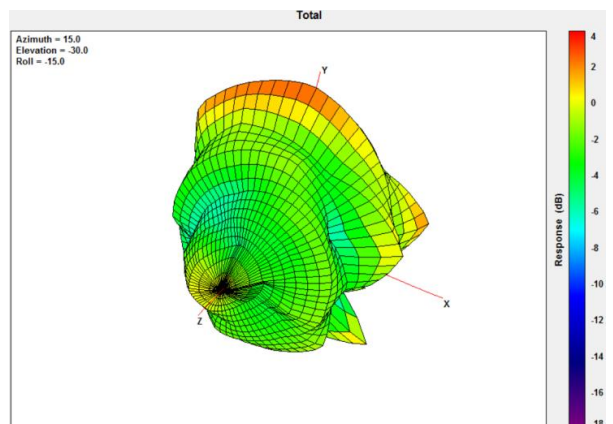

3500MHz

3.3.3 2D Radiation Pattern (LTE MIMO2 with 3M cable length in free space)

XY Plane

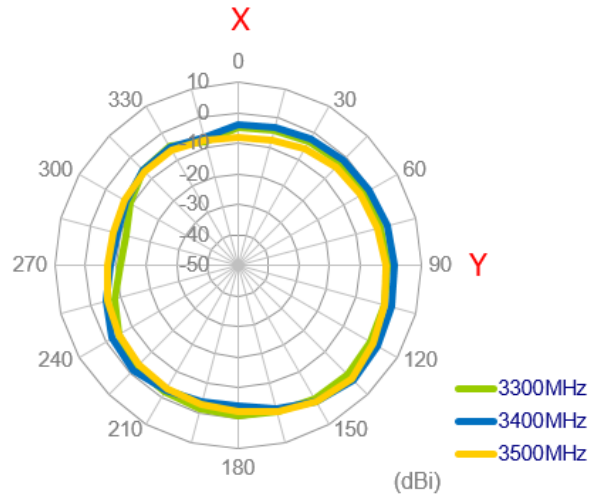
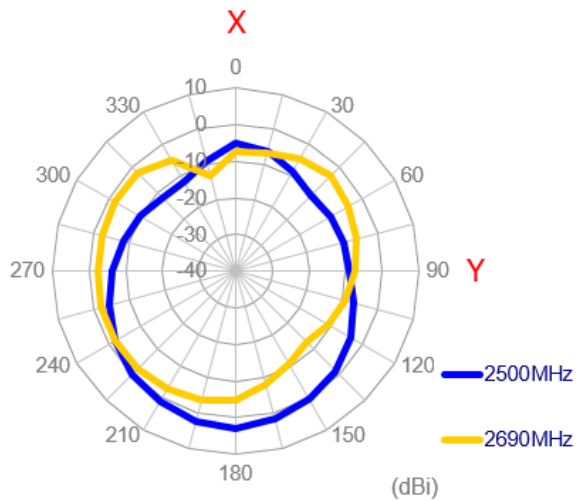
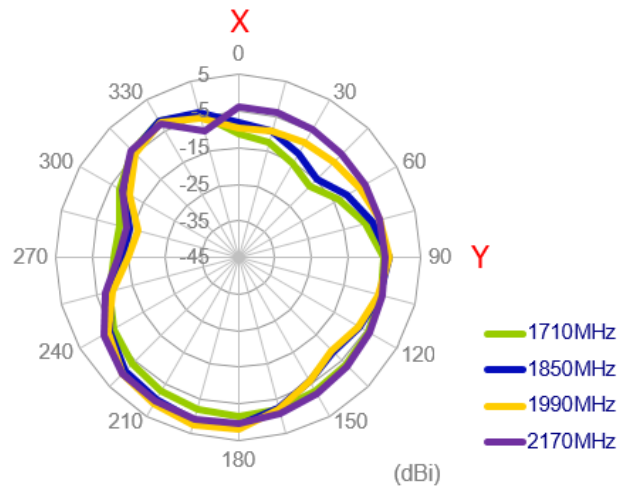
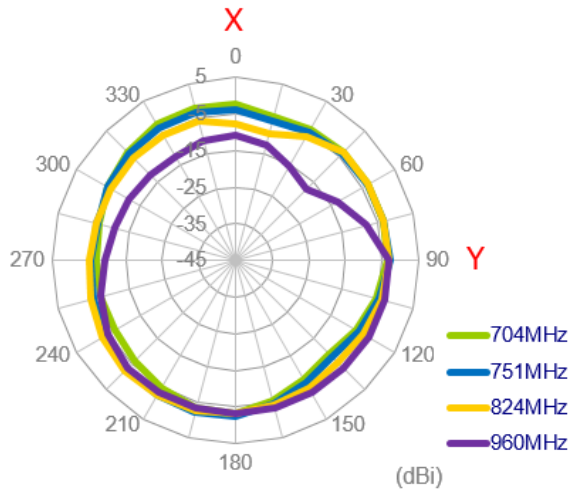

XZ Plane

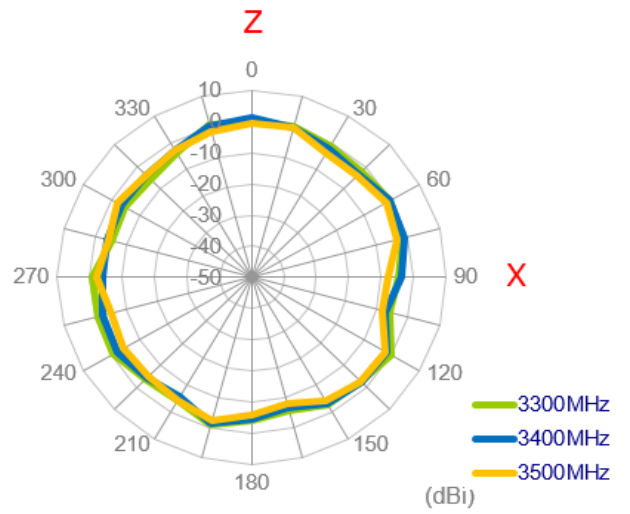
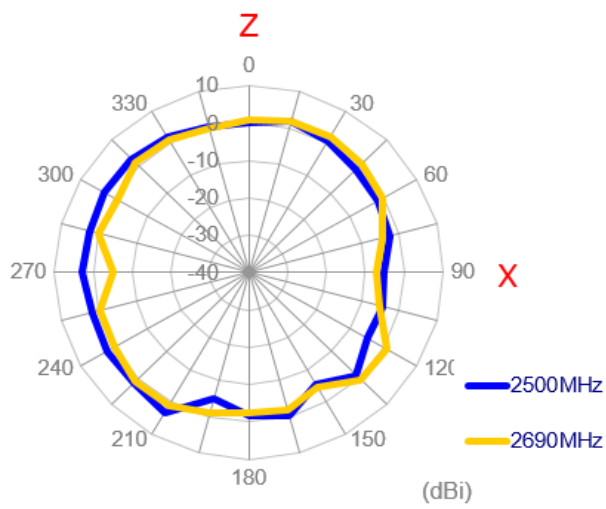
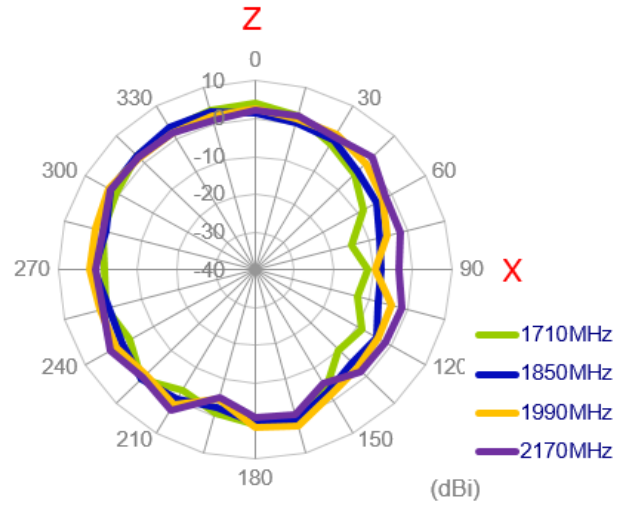
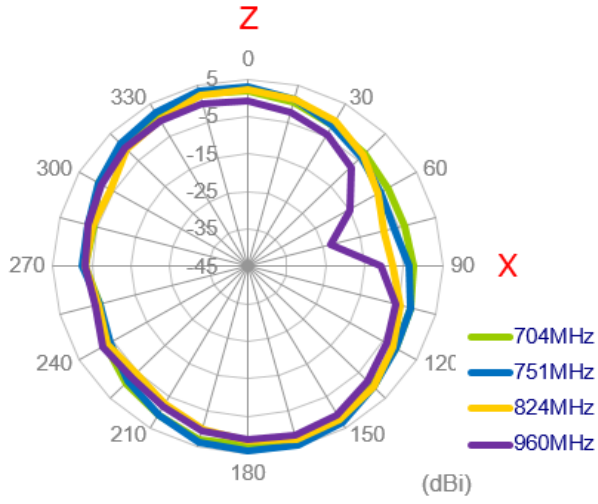

YZ Plane

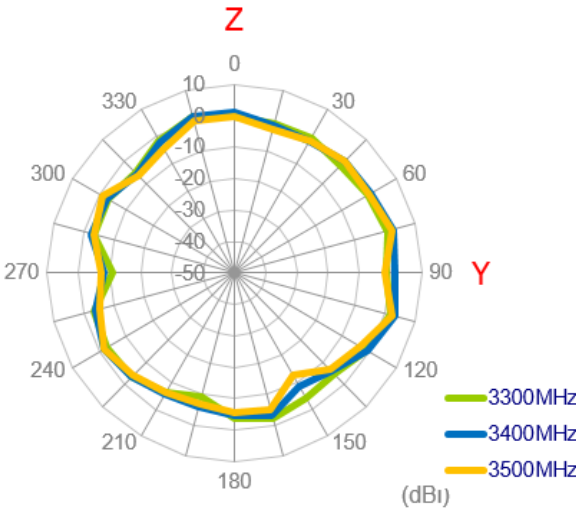
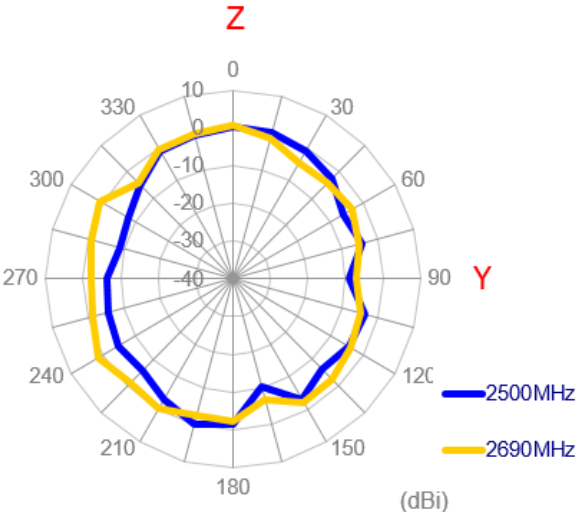
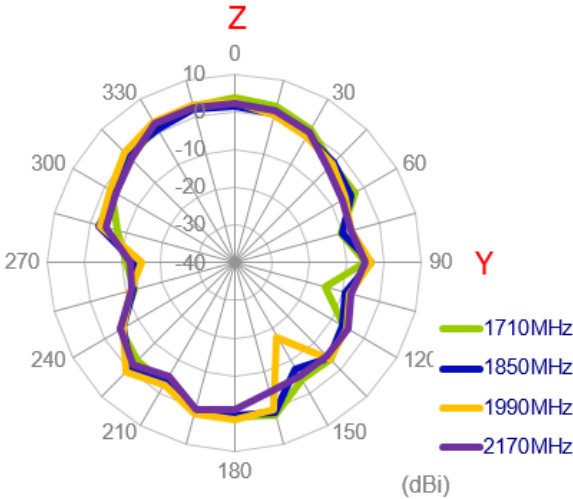
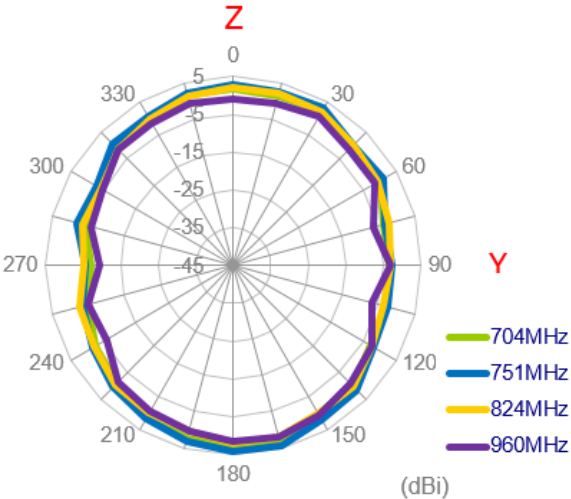

3.1.24 3D Radiation Pattern (LTE MIMO2 with 1M cable length in free space)

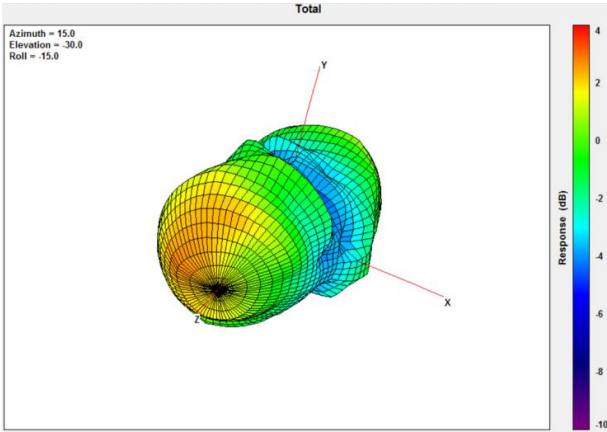

704MHz

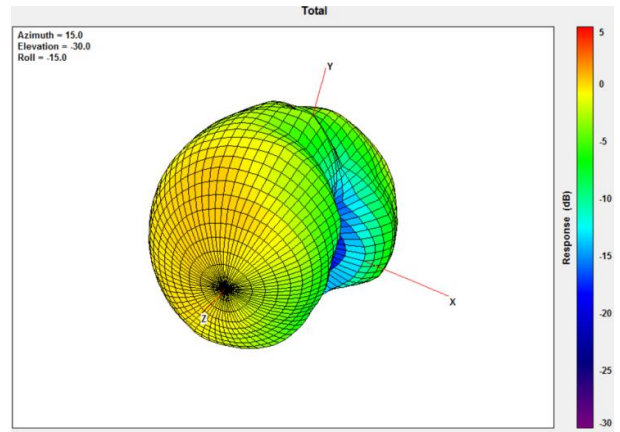

960MHz

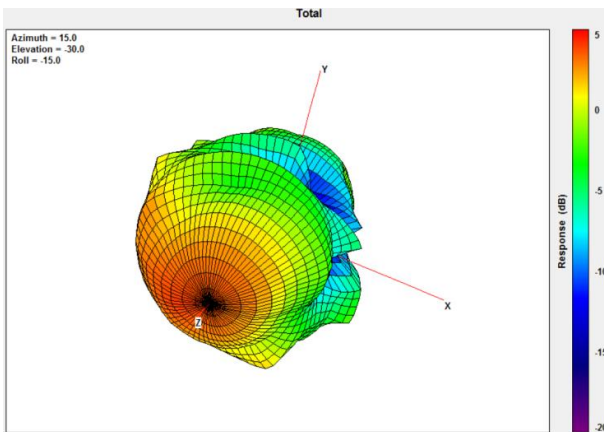

1710MHz

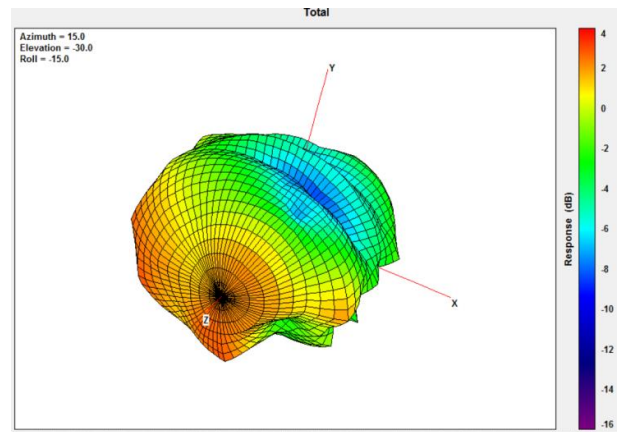

2170MHz

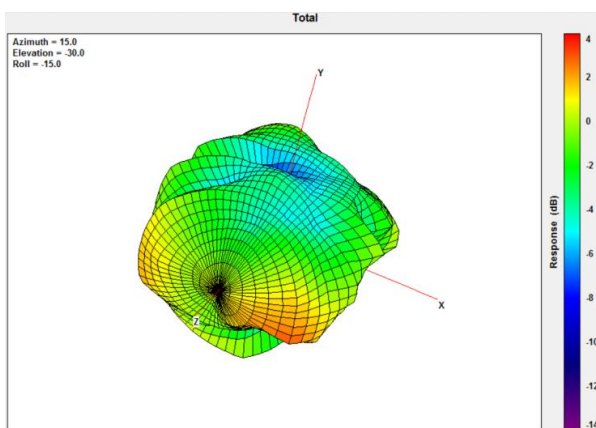

2690MHz

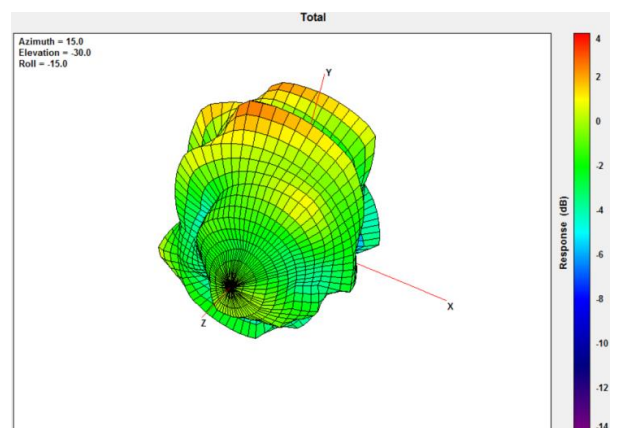

3500MHz

3.3.5 2D Radiation Pattern (Wi-Fi MIMO1 with 3M cable length in free space)

XY Plane

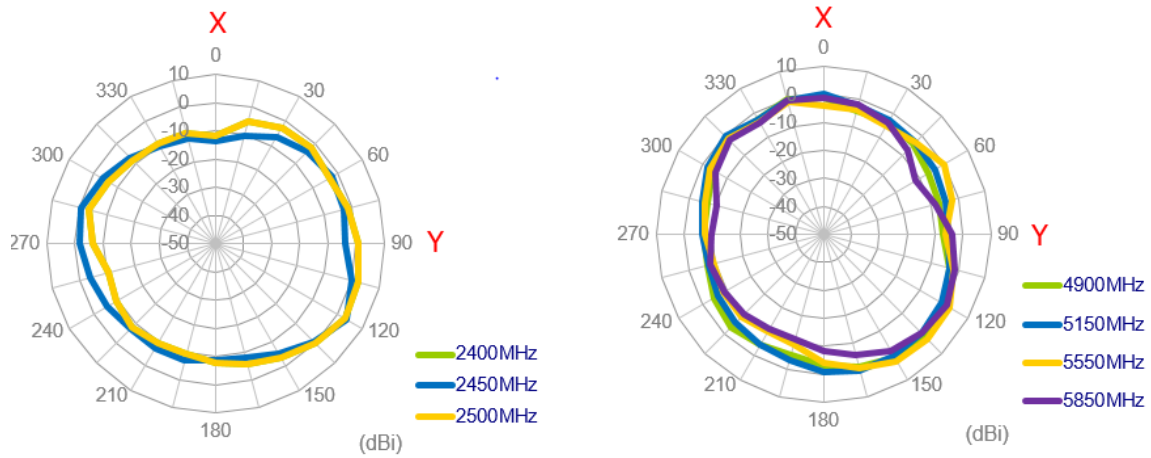

XZ Plane

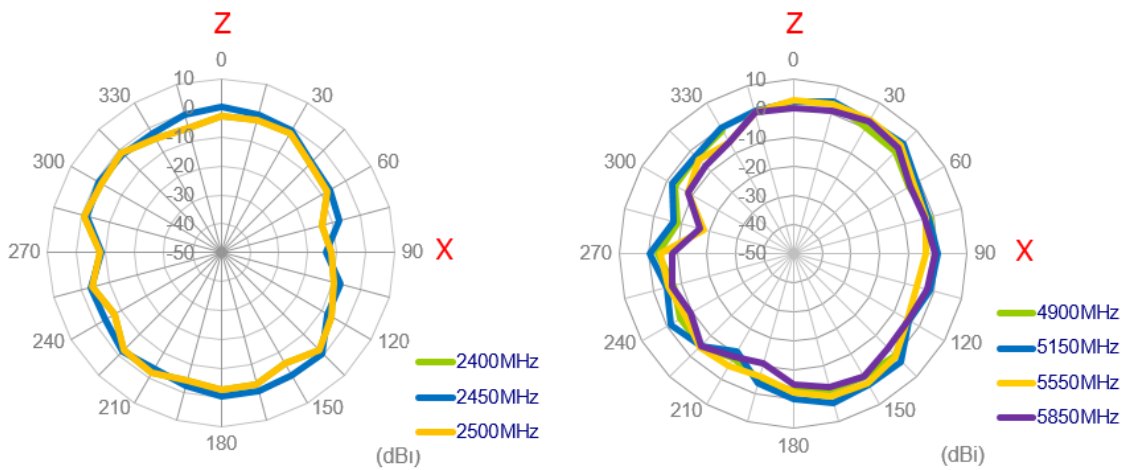

YZ Plane

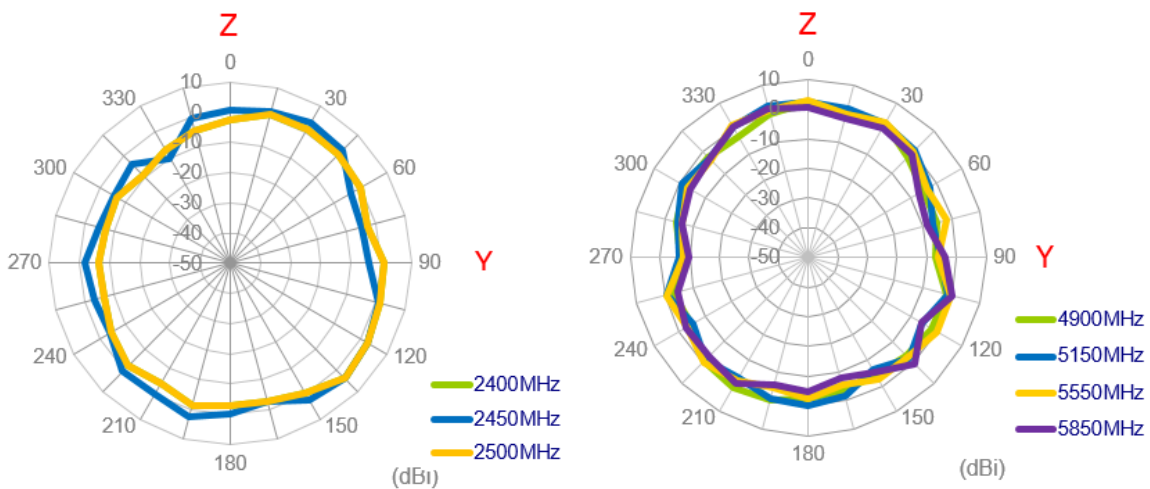

3.3.6 3D Radiation Pattern (Wi-Fi MIMO1 with 3M cable length in free space)

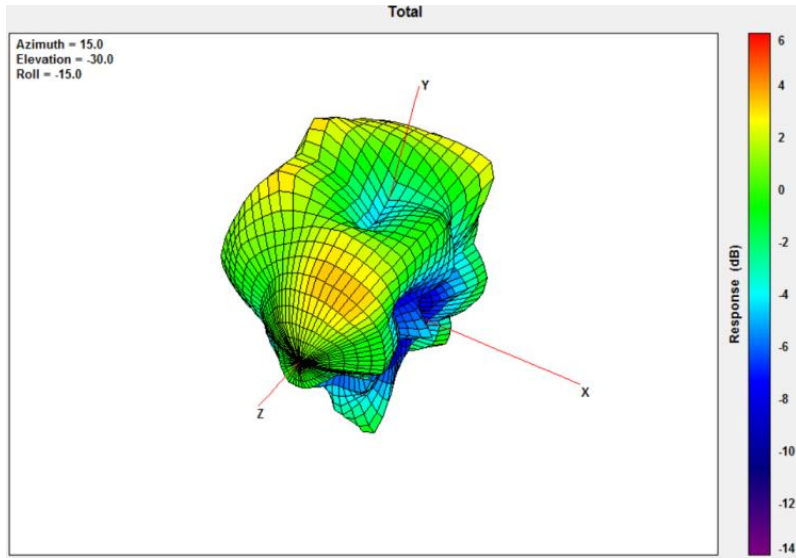

2450MHz

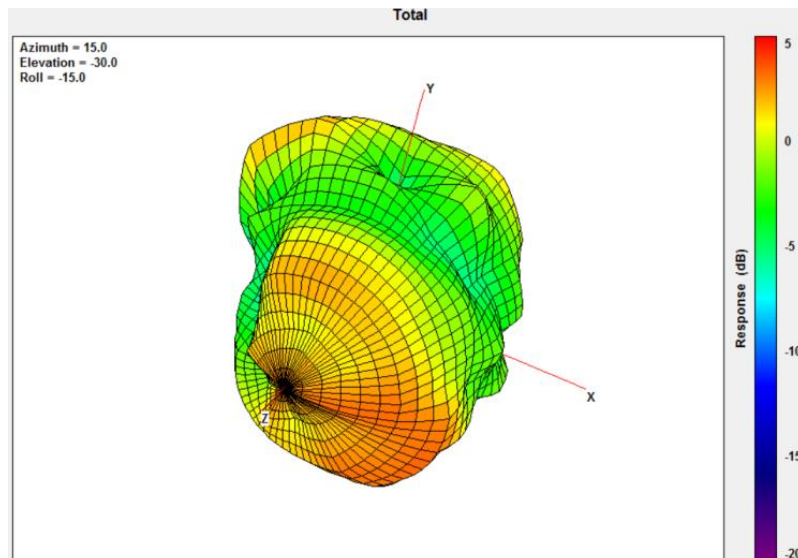

5550MHz

3.3.7 2D Radiation Pattern (Wi-Fi MIMO2 with 3M cable length in free space)

XY Plane

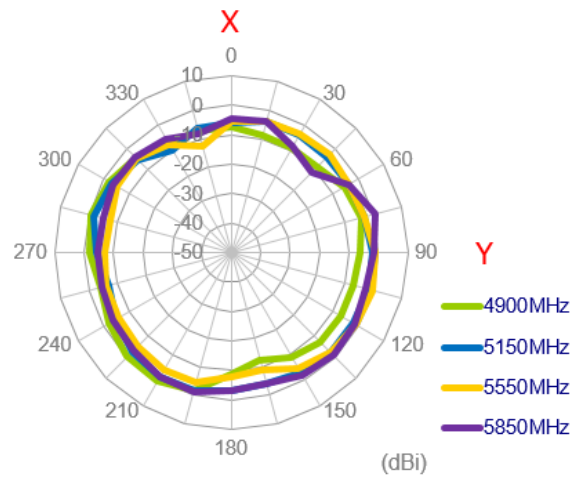
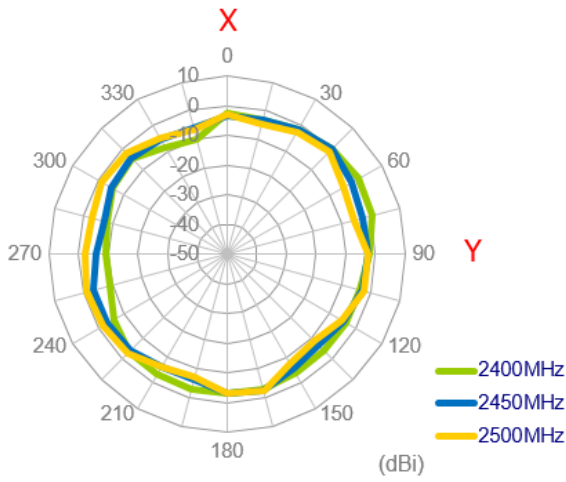

XZ Plane

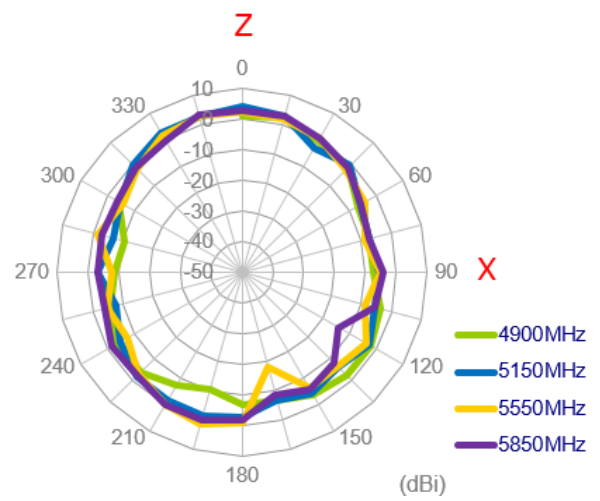
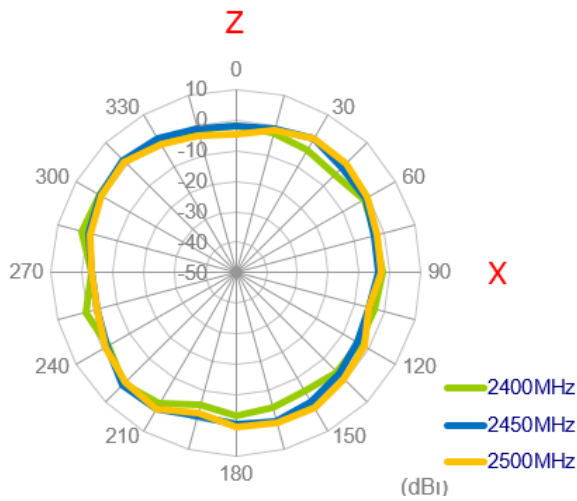

YZ Plane

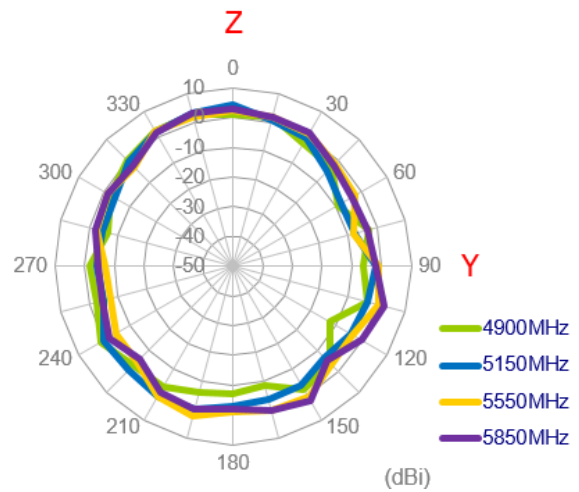
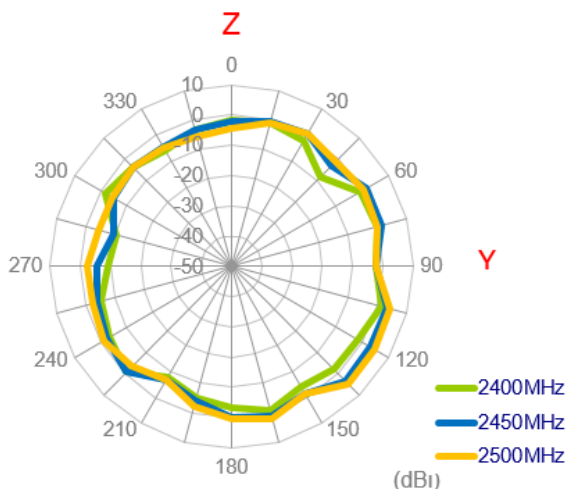

3.3.8 3D Radiation Pattern (Wi-Fi MIMO2 with 3M cable length in free space)

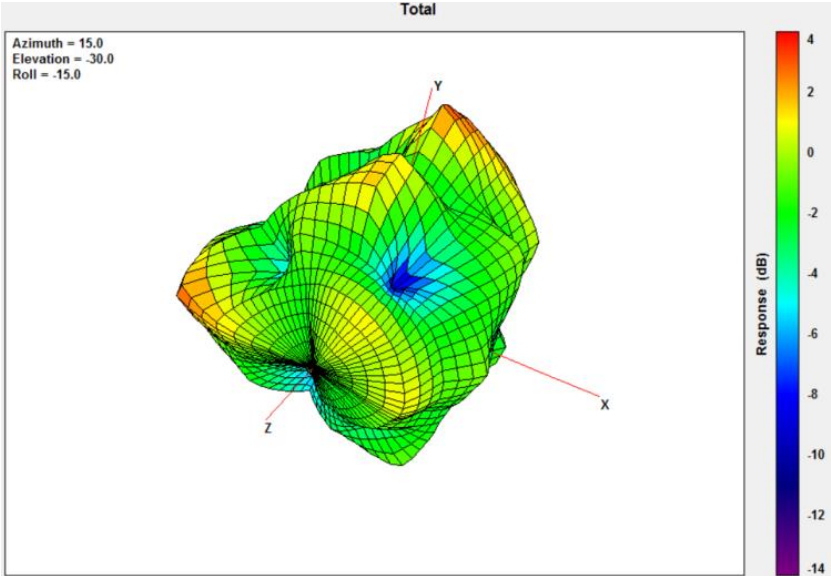

2450MHz

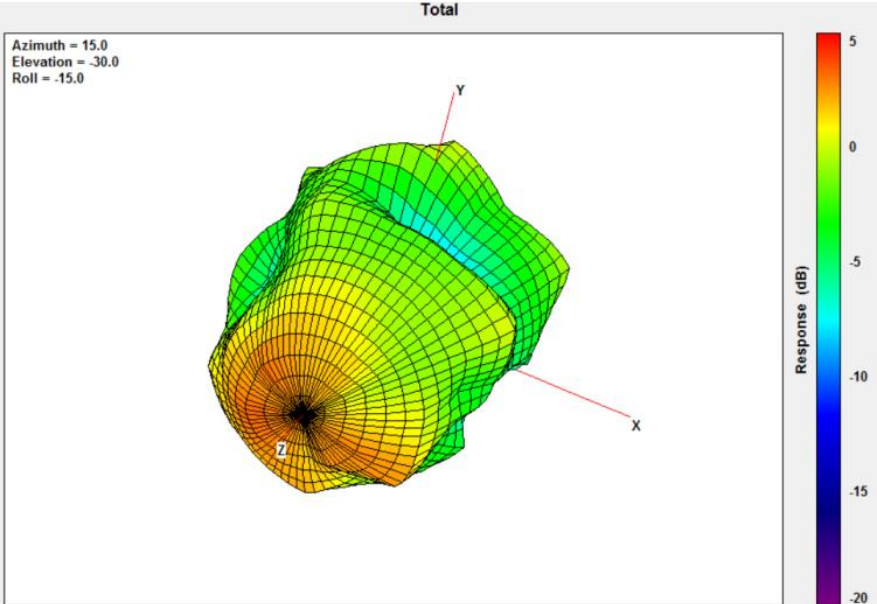

5550MHz

4. Mechanical Drawing (Unit: mm)

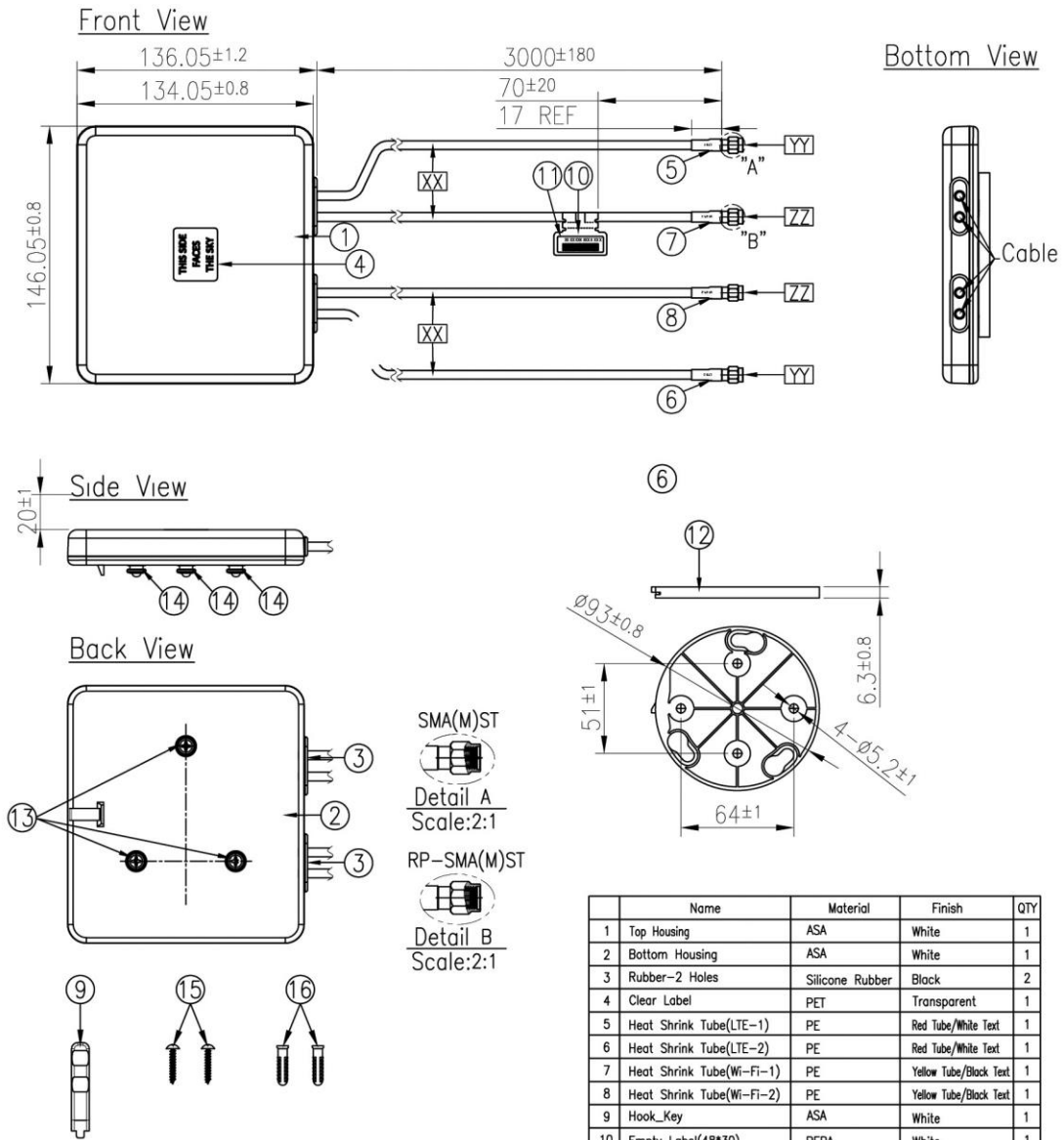

	Name	Material	Finish	QTY
1	Top Housing	ASA	White	1
2	Bottom Housing	ASA	White	1
3	Rubber-2 Holes	Silicone Rubber	Black	2
4	Clear Label	PET	Transparent	1
5	Heat Shrink Tube(LTE-1)	PE	Red Tube/White Text	1
6	Heat Shrink Tube(LTE-2)	PE	Red Tube/White Text	1
7	Heat Shrink Tube(Wi-Fi-1)	PE	Yellow Tube/Black Text	1
8	Heat Shrink Tube(Wi-Fi-2)	PE	Yellow Tube/Black Text	1
9	Hook_Key	ASA	White	1
10	Empty Label(48*30)	PEPA	White	1
11	Barcode Label(25*9)	PET	White	1
12	MA9 Series Bracket	ASA	White	1
13	Screw TP1(3x8L)	Steel	Ni Plated	3
14	Fastening Washer	ASA	White	3
15	Screw TP4x25L	Steel	Ni Plated	2
16	Wall mount stud 6x24L	Nylon	White	2

	Name	SPEC	Finish	QTY
XX	Cable Type	SR200-P	Black	4
YY	Connector Type(KSR200-P)	SMA(M)ST	Au Plated	2
ZZ	Connector Type(KSR200-P)	RP-SMA(M)ST	Au Plated	2

5. Packaging

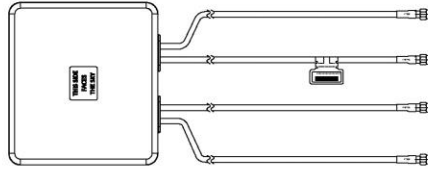

1 MA961.W.A.BICG.002.wm per small box
 Box Dimensions - 260 x 235 x 105mm
 Weight - 1000g

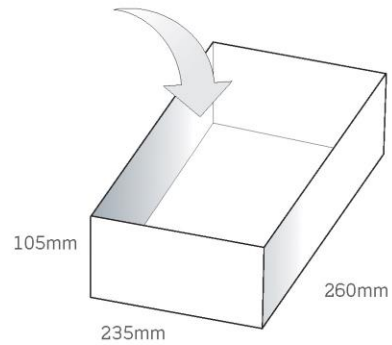

1 Outer Carton
 Carton Dimensions - 540 x 490 x 240mm
 8 pcs MA961.W.A.BICG.002.wm per carton
 Weight - 9.01Kg

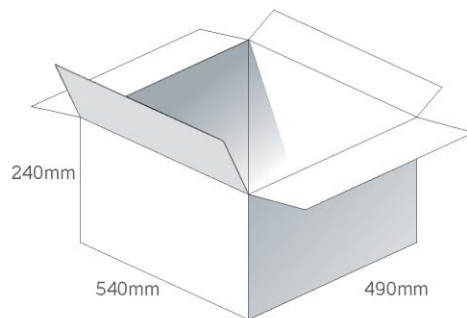

Pallet Dimensions 1200*1000*1400mm
 20 Cartons per Pallet
 4 Cartons per layer
 5 Layers

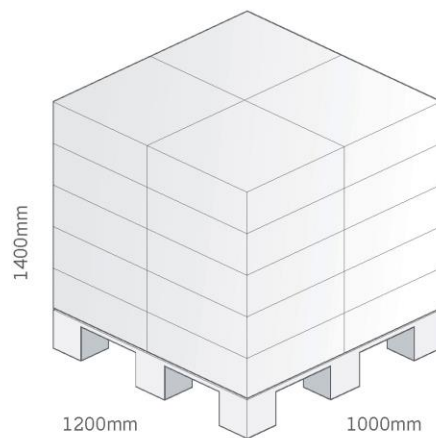

6. Application Note

The MA961 antenna performance with different cable lengths is shown below.

6.1 In free space (LTE)

6.1.1 Return Loss (LTE MIMO 1)

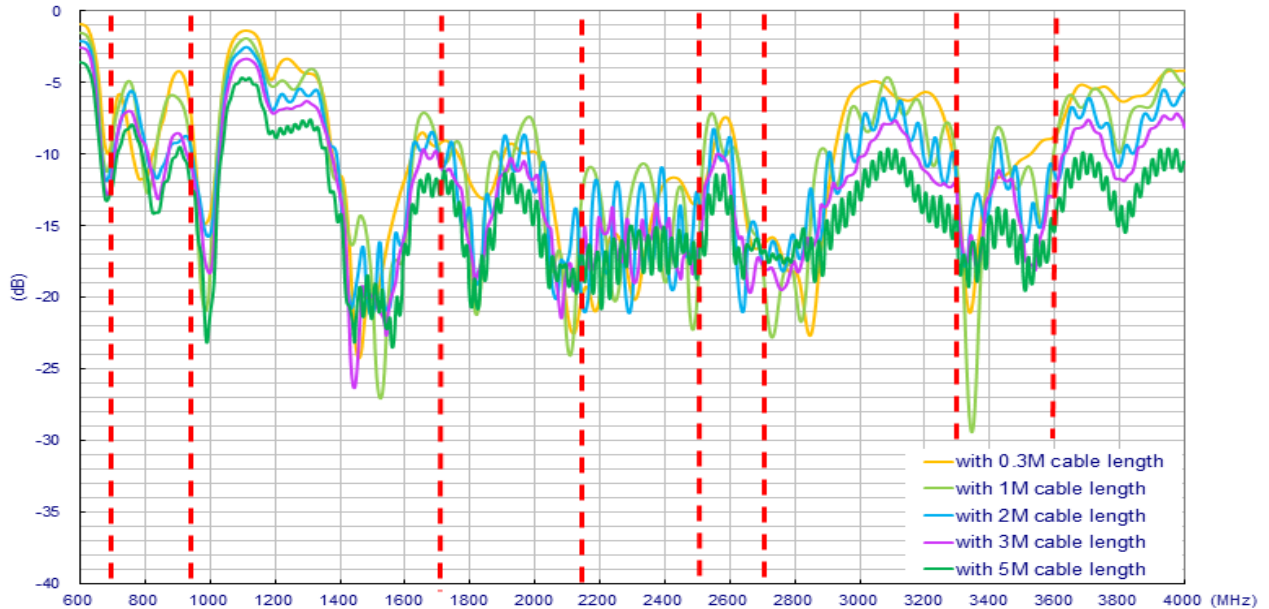

6.1.2 Return Loss (LTE MIMO 2)

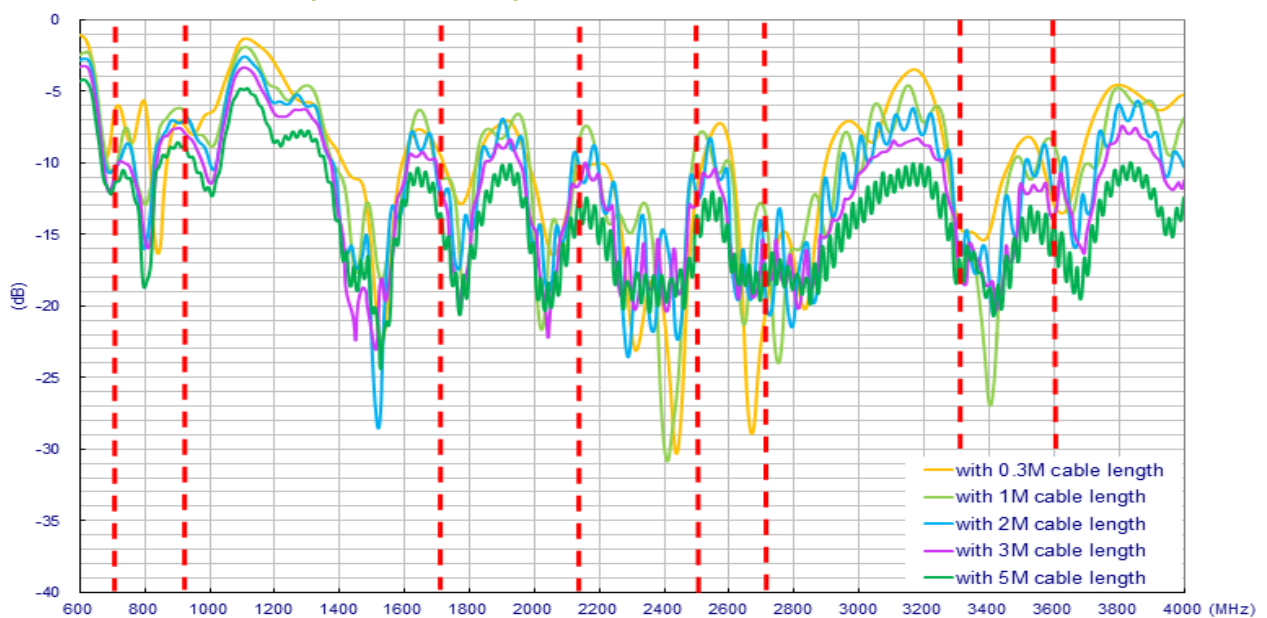

6.1.3 Isolation (LTE antenna)

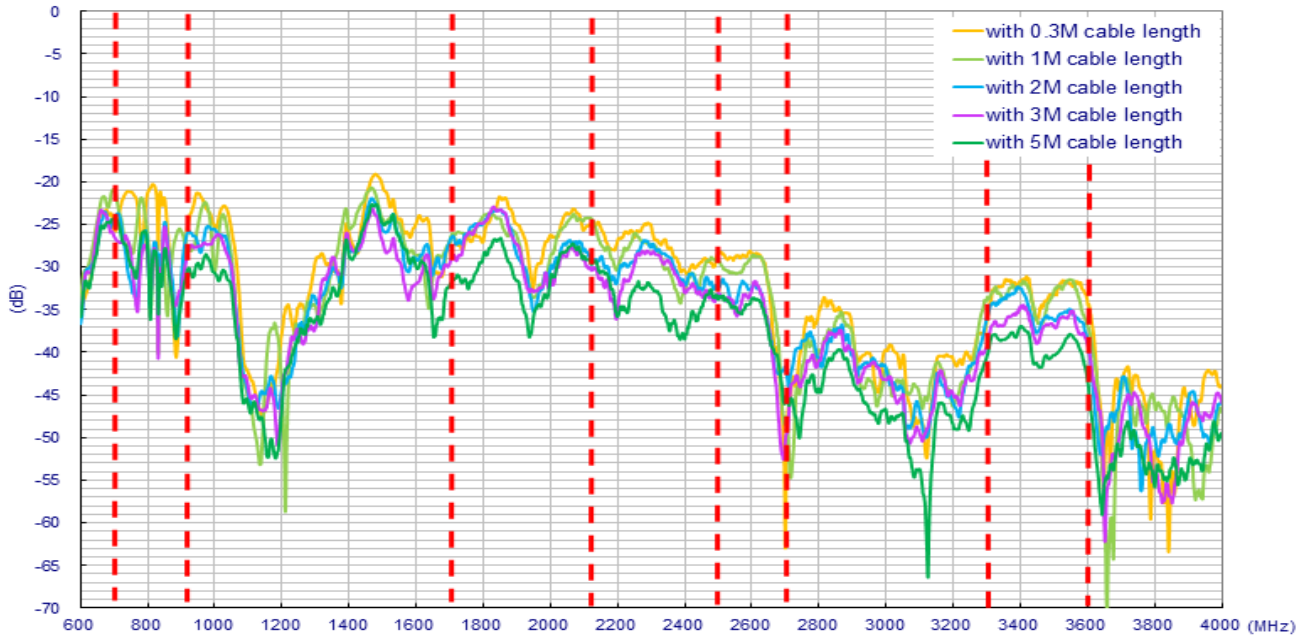

6.1.4 Efficiency (LTE MIMO 1)

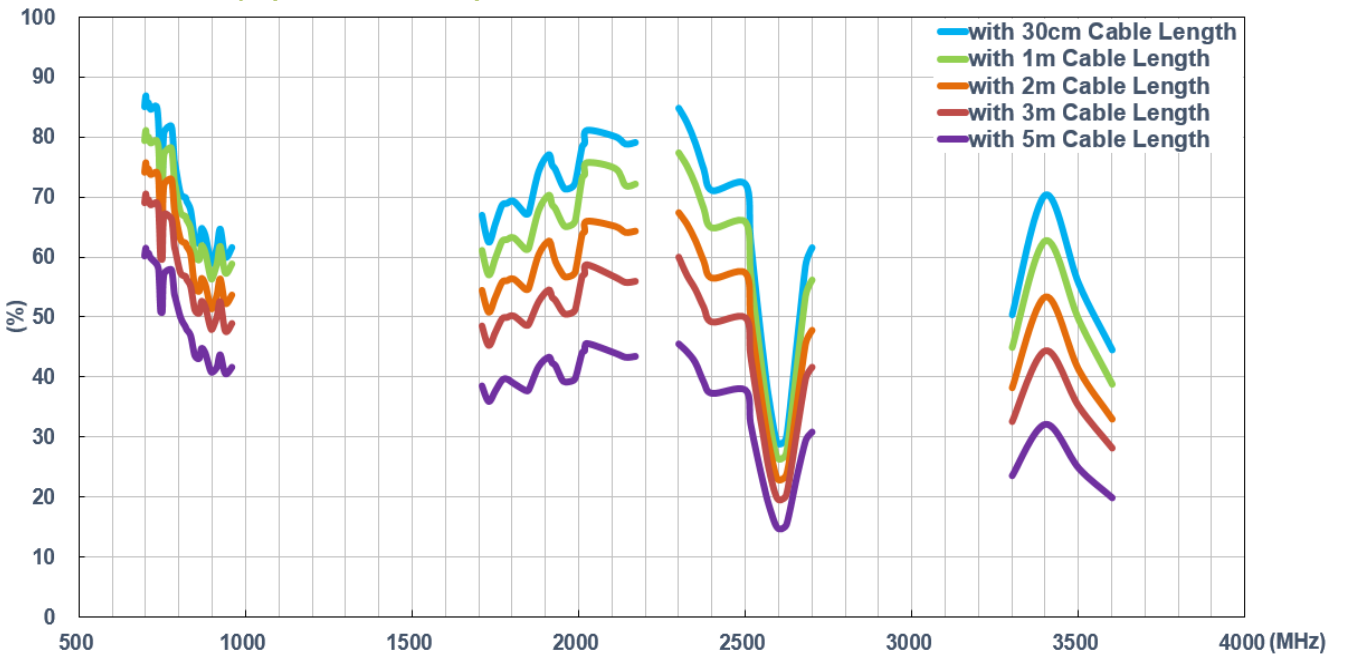

6.1.5 Efficiency (LTE MIMO 2)

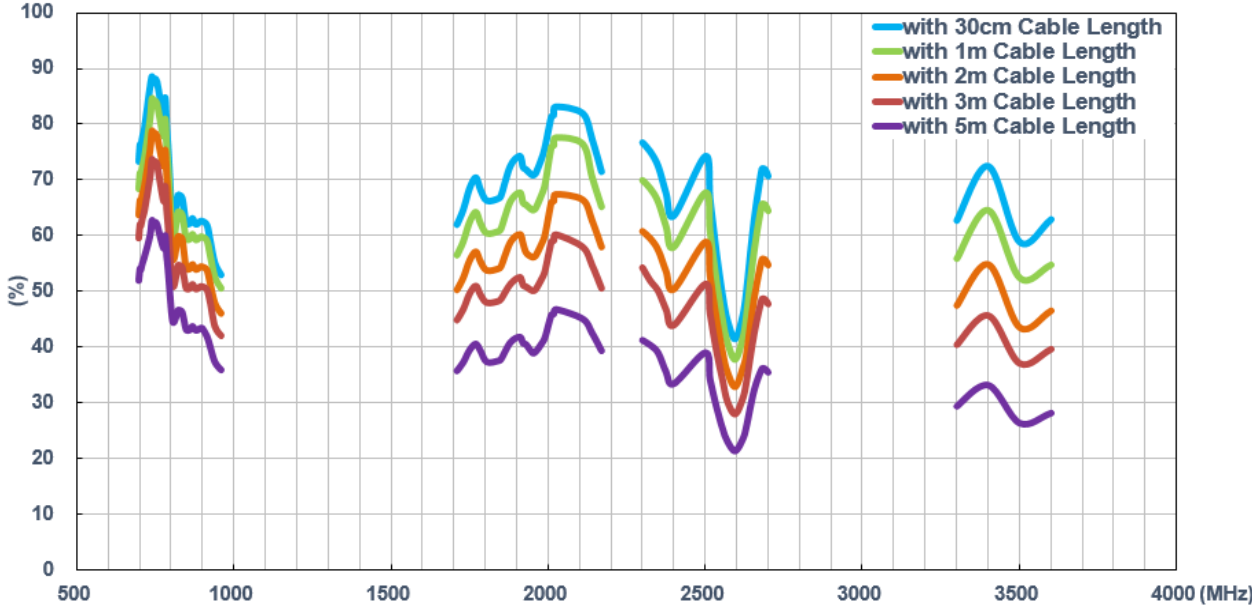

6.1.6 Average Gain (LTE MIMO 1)

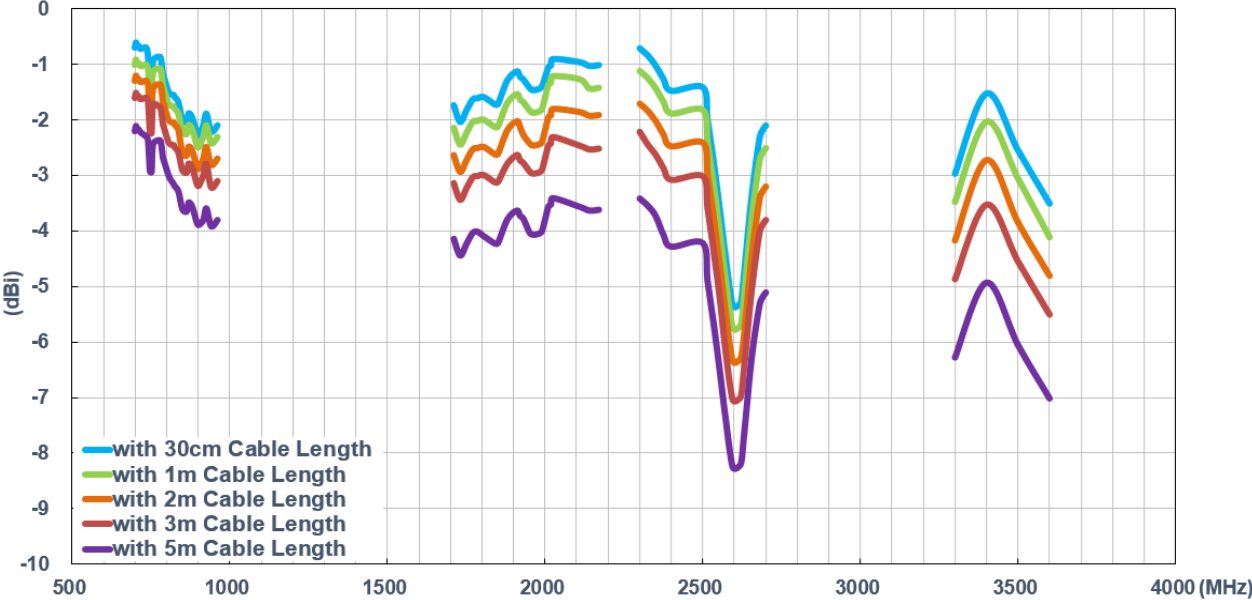

6.1.7 Average Gain (LTE MIMO 2)

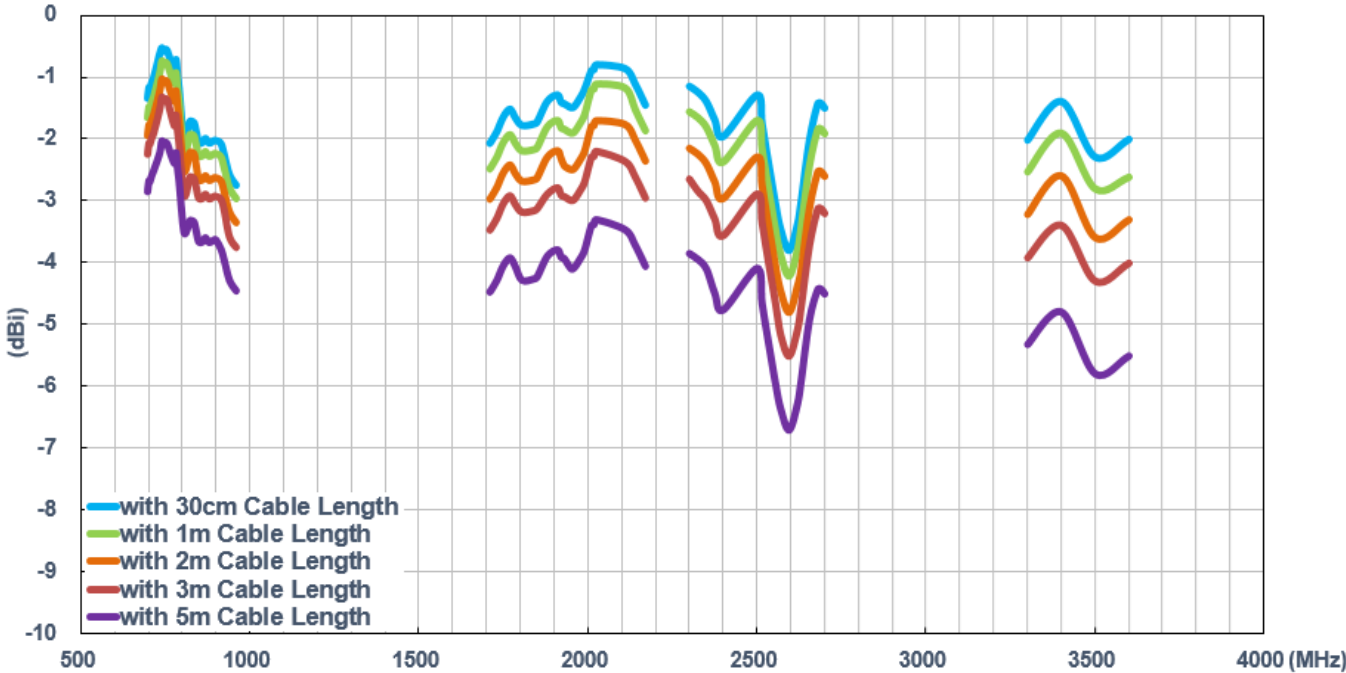

6.1.8 Peak Gain (LTE MIMO 1)

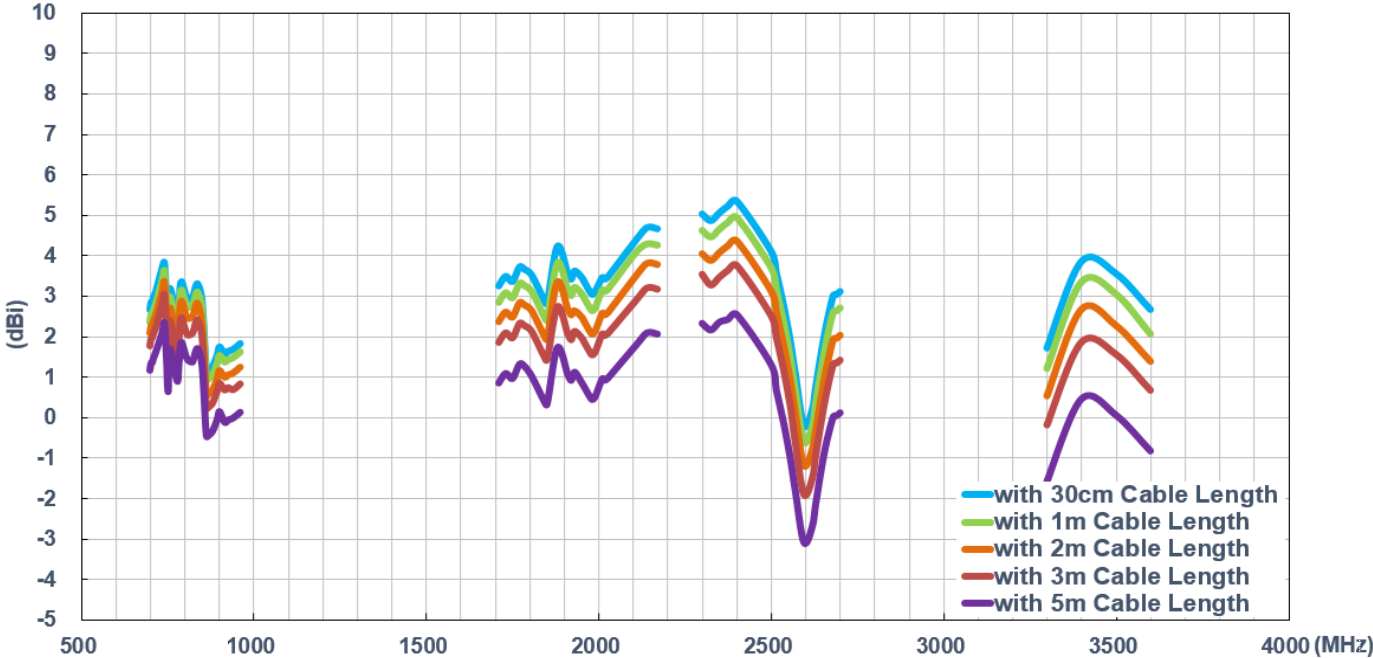

6.1.9 Peak Gain (LTE MIMO 2)

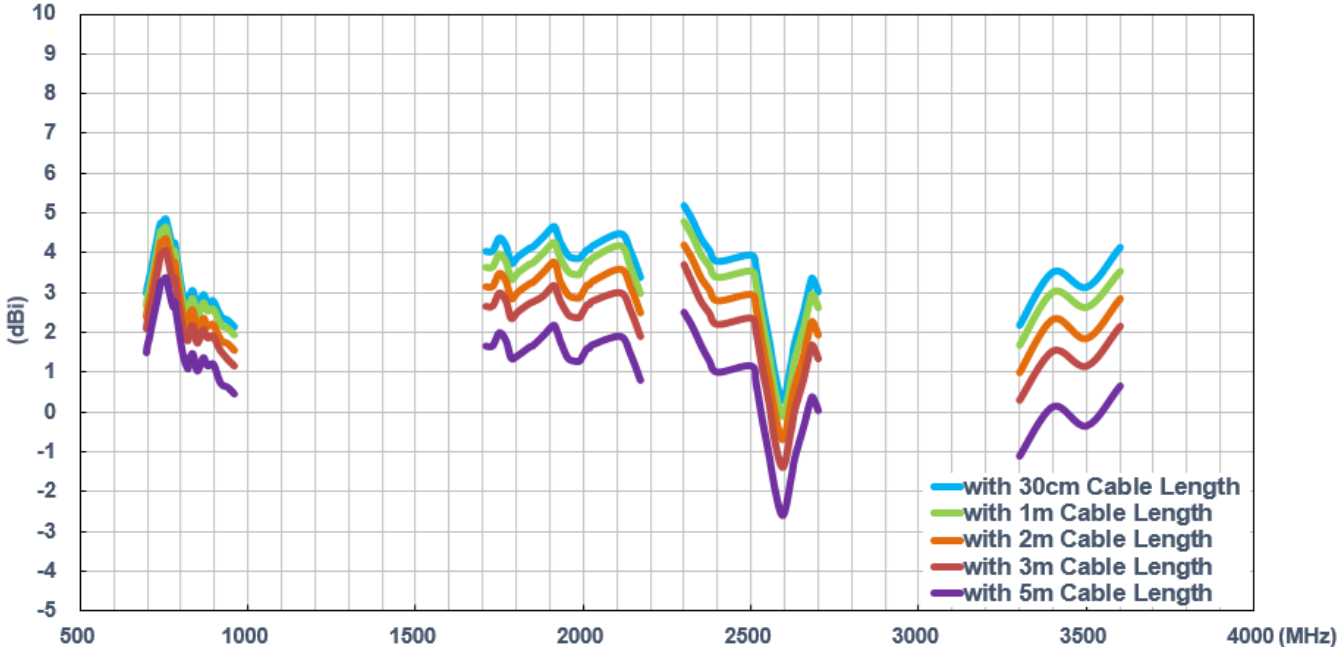

6.2 In free space (Wi-Fi)

6.2.1 Return Loss (Wi-Fi MIMO 1)

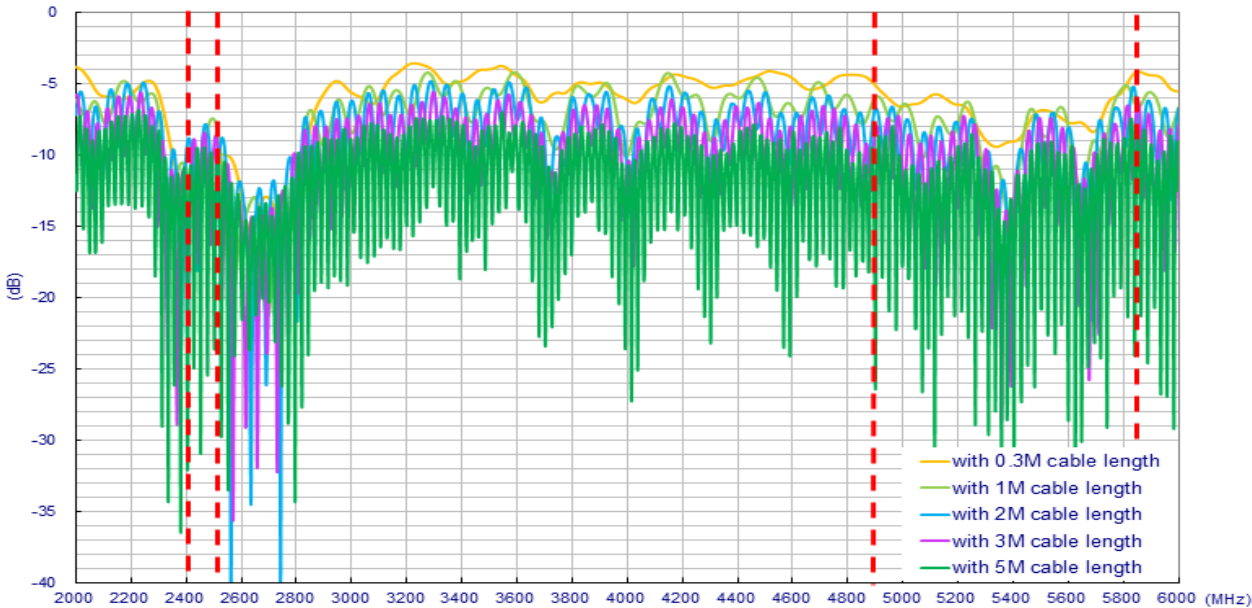

6.2.2 Return Loss (Wi-Fi MIMO 2)

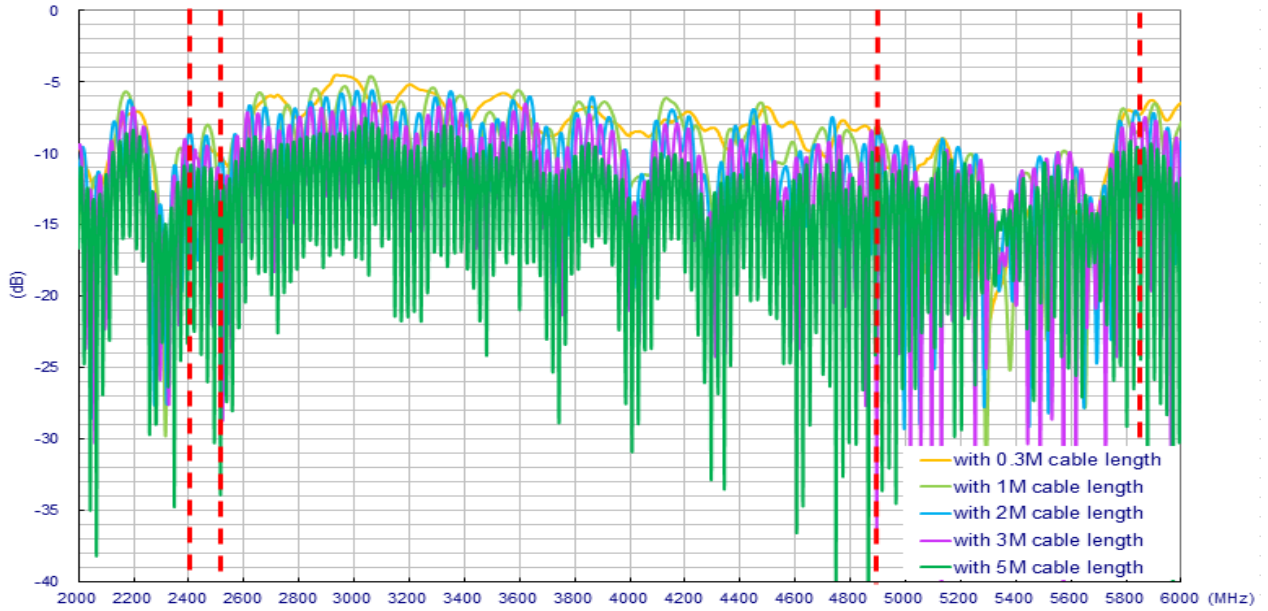

6.2.3 Isolation (Wi-Fi)

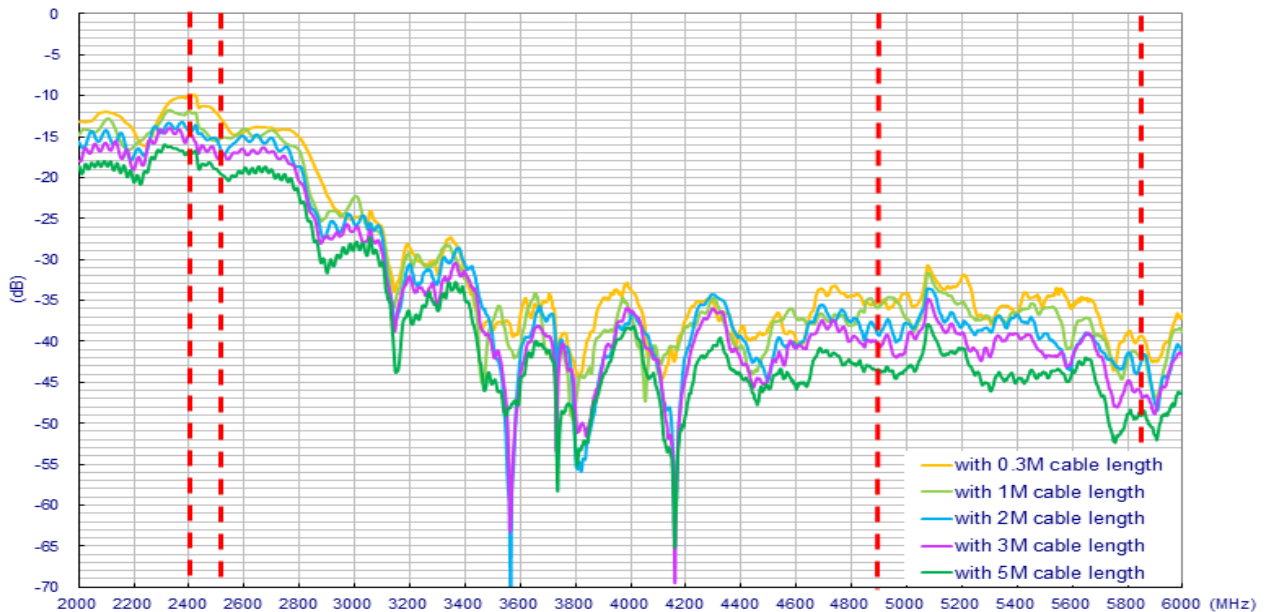

6.2.4 Efficiency (Wi-Fi MIMO 1)

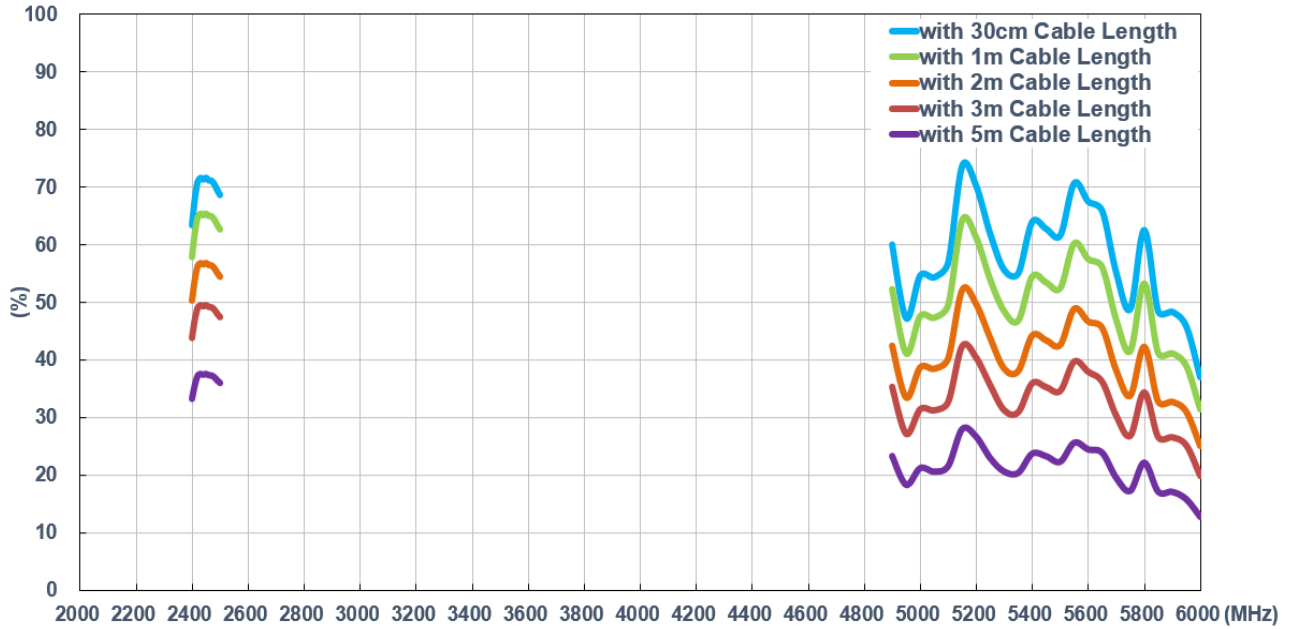

6.2.5 Efficiency (Wi-Fi MIMO 2)

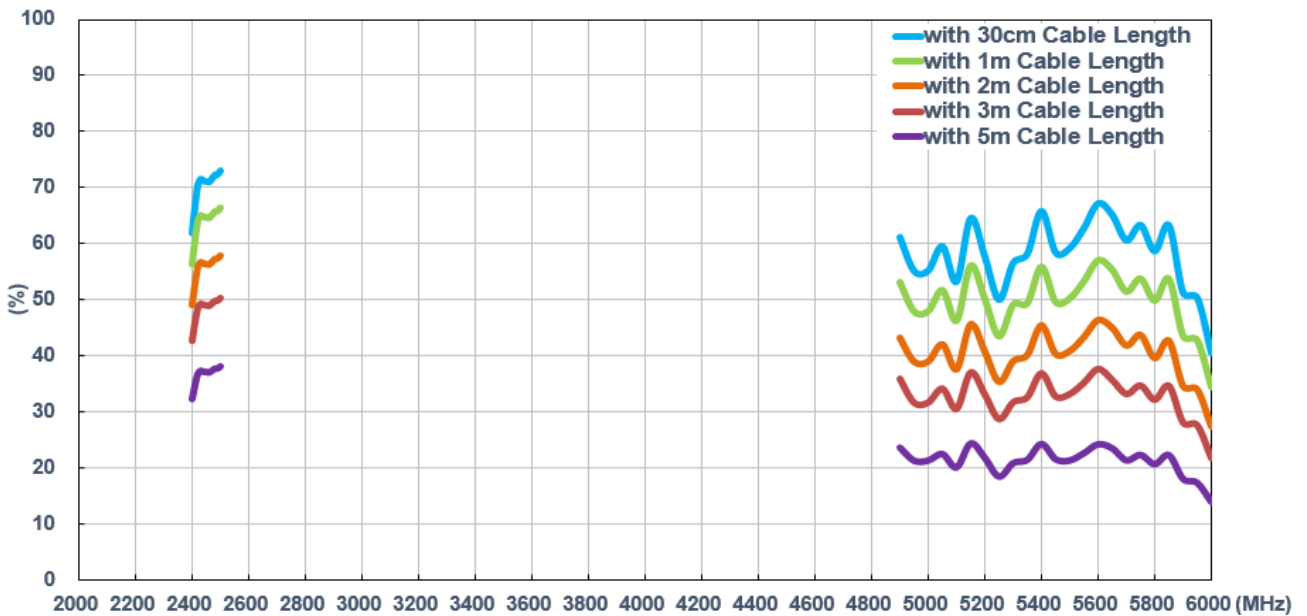

6.2.6 Average Gain (Wi-Fi MIMO 1)

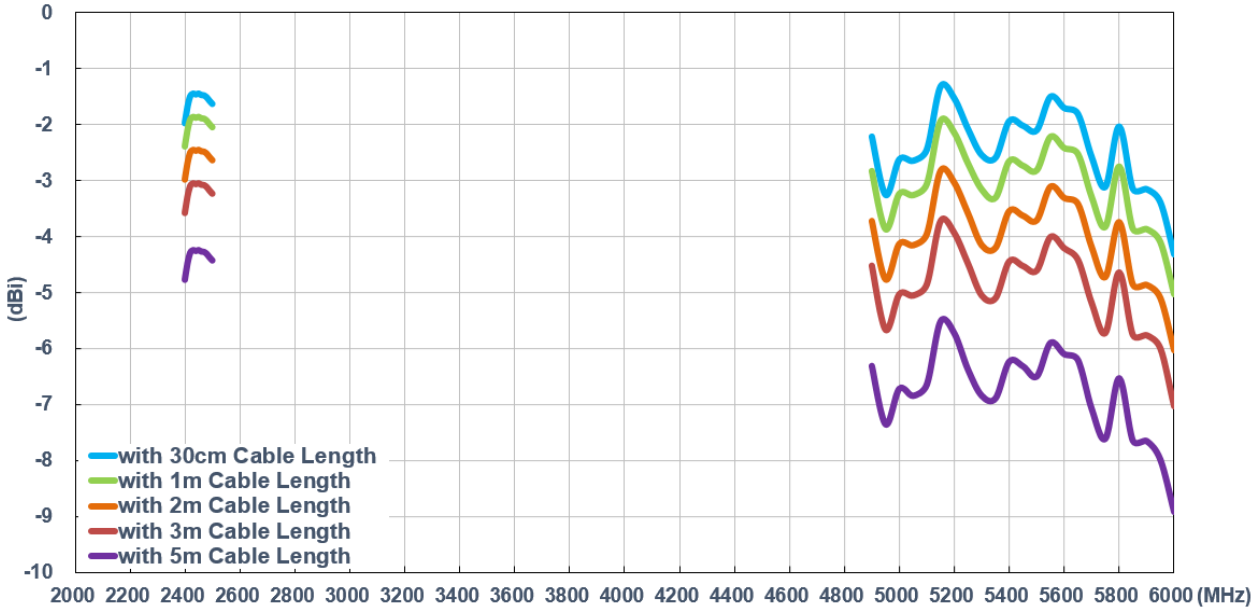

6.2.7 Average Gain (Wi-Fi MIMO 2)

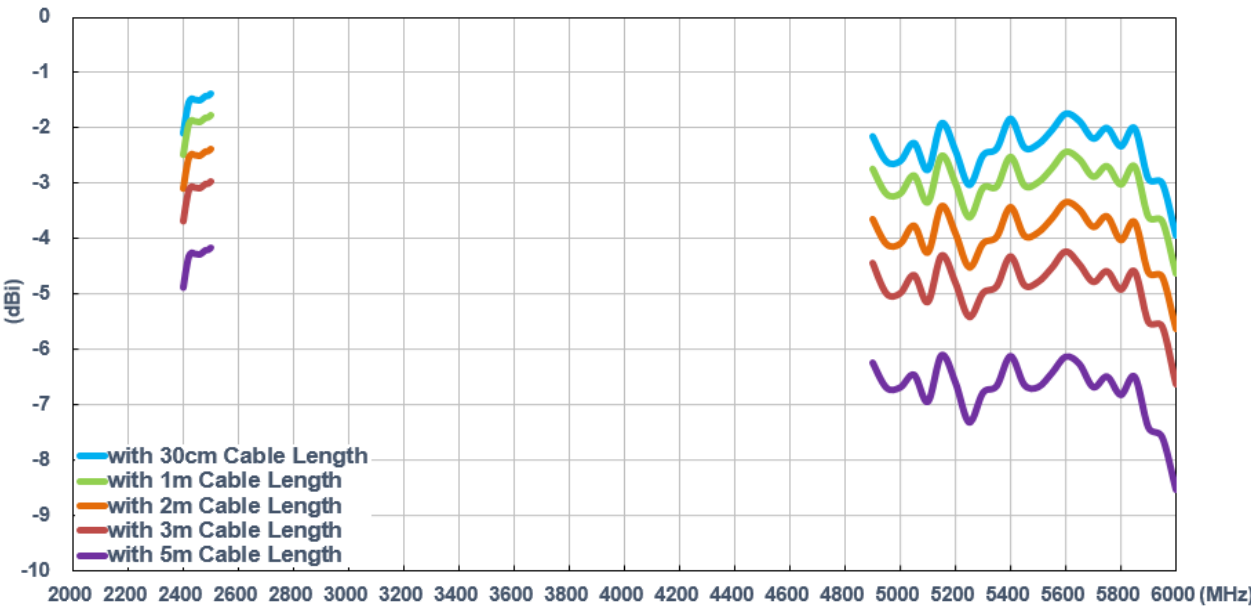

6.2.8 Peak Gain (Wi-Fi MIMO 1)

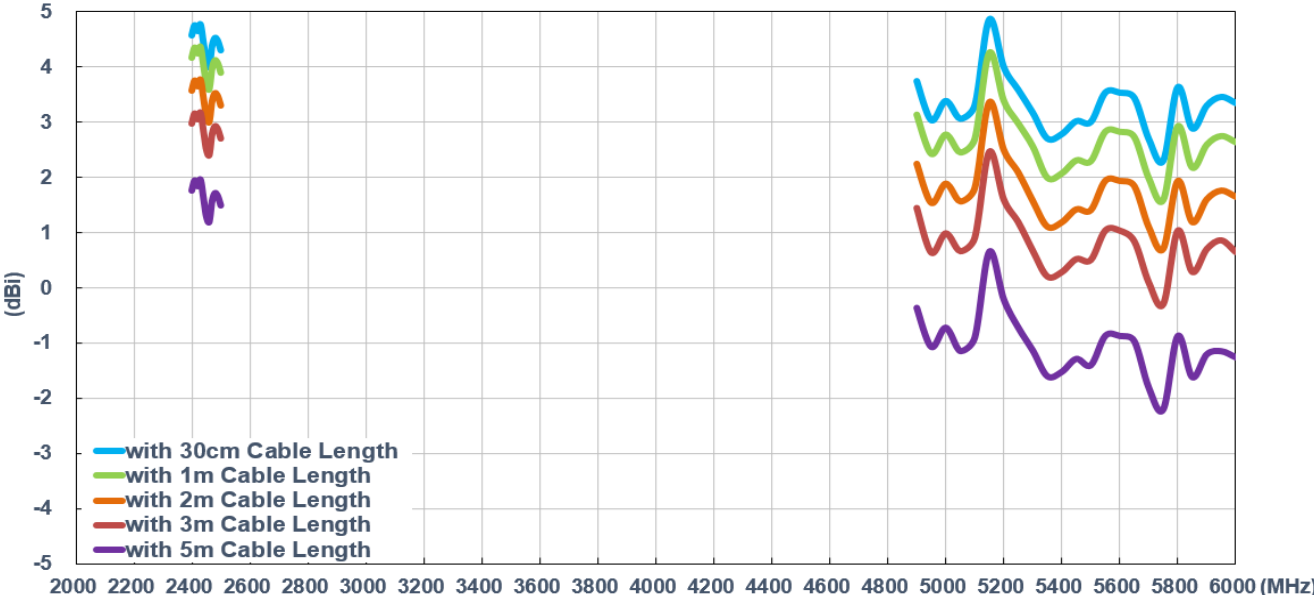

6.2.9 Peak Gain (Wi-Fi MIMO 2)

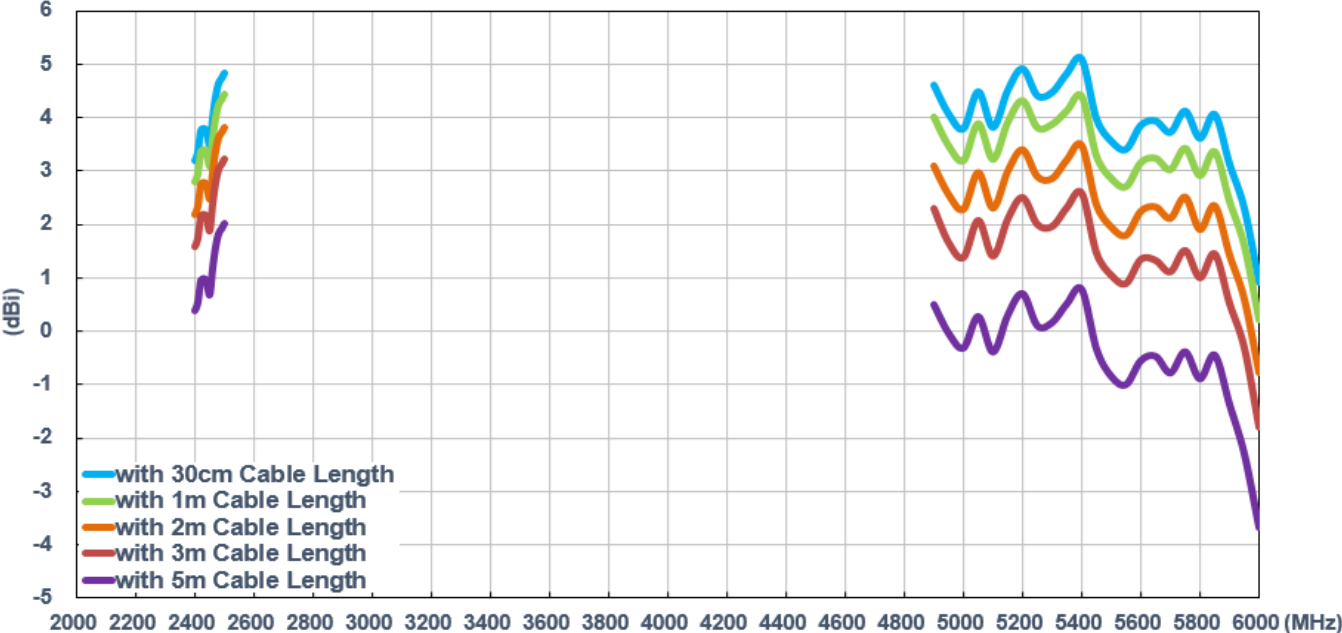

7. Installation Instructions

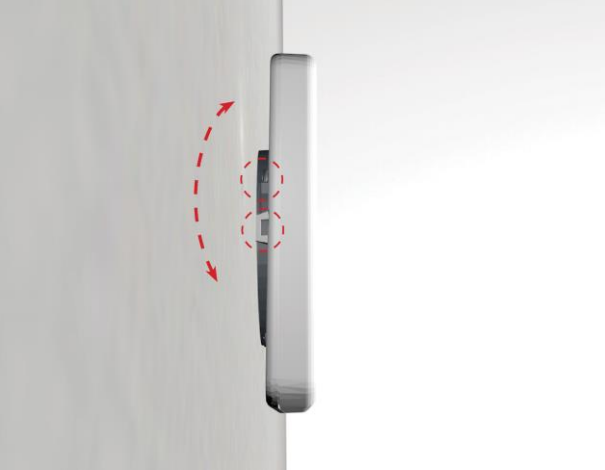
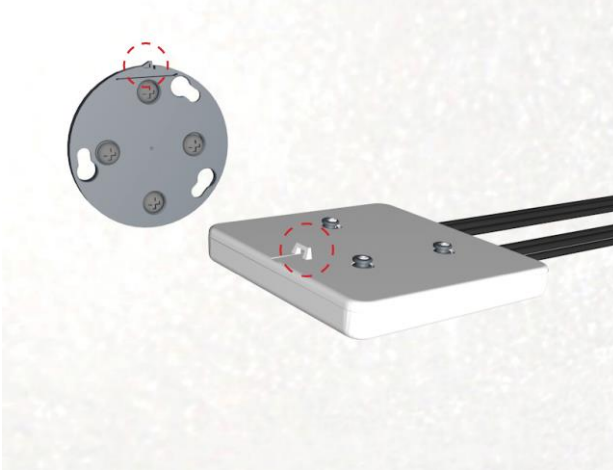
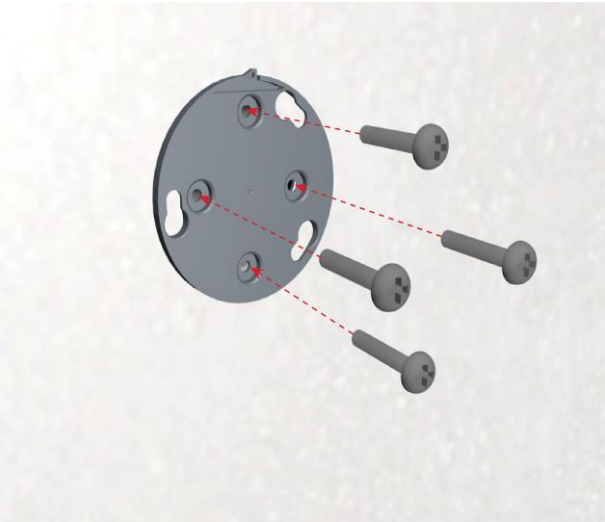
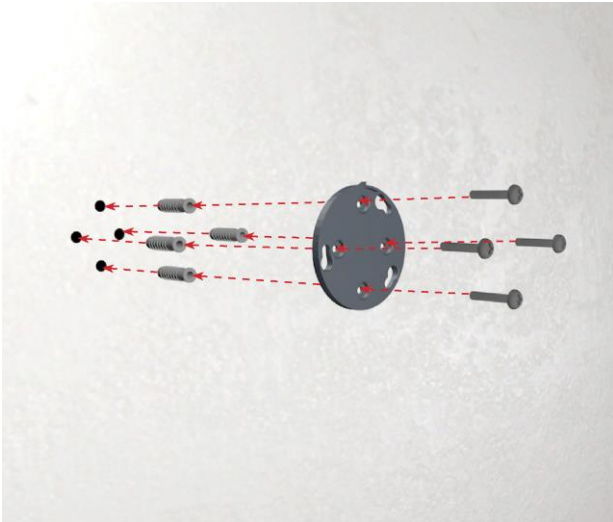

Taoglas makes no warranties based on the accuracy or completeness of the contents of this document and reserves the right to make changes to specifications and product descriptions at any time without notice. Taoglas reserves all rights to this document and the information contained herein.

Reproduction, use or disclosure to third parties without express permission is strictly prohibited.

Copyright © Taoglas Ltd.